

ÍNDICE

RETENTORES

Retentores.....	9
V'Rings.....	49
Ret. Rotary.....	53
Tabela de Conversão.....	55

Alguns modelos com particularidades de montagem para a mesma finalidade.
Vedação de eixo utilizada em mancais.

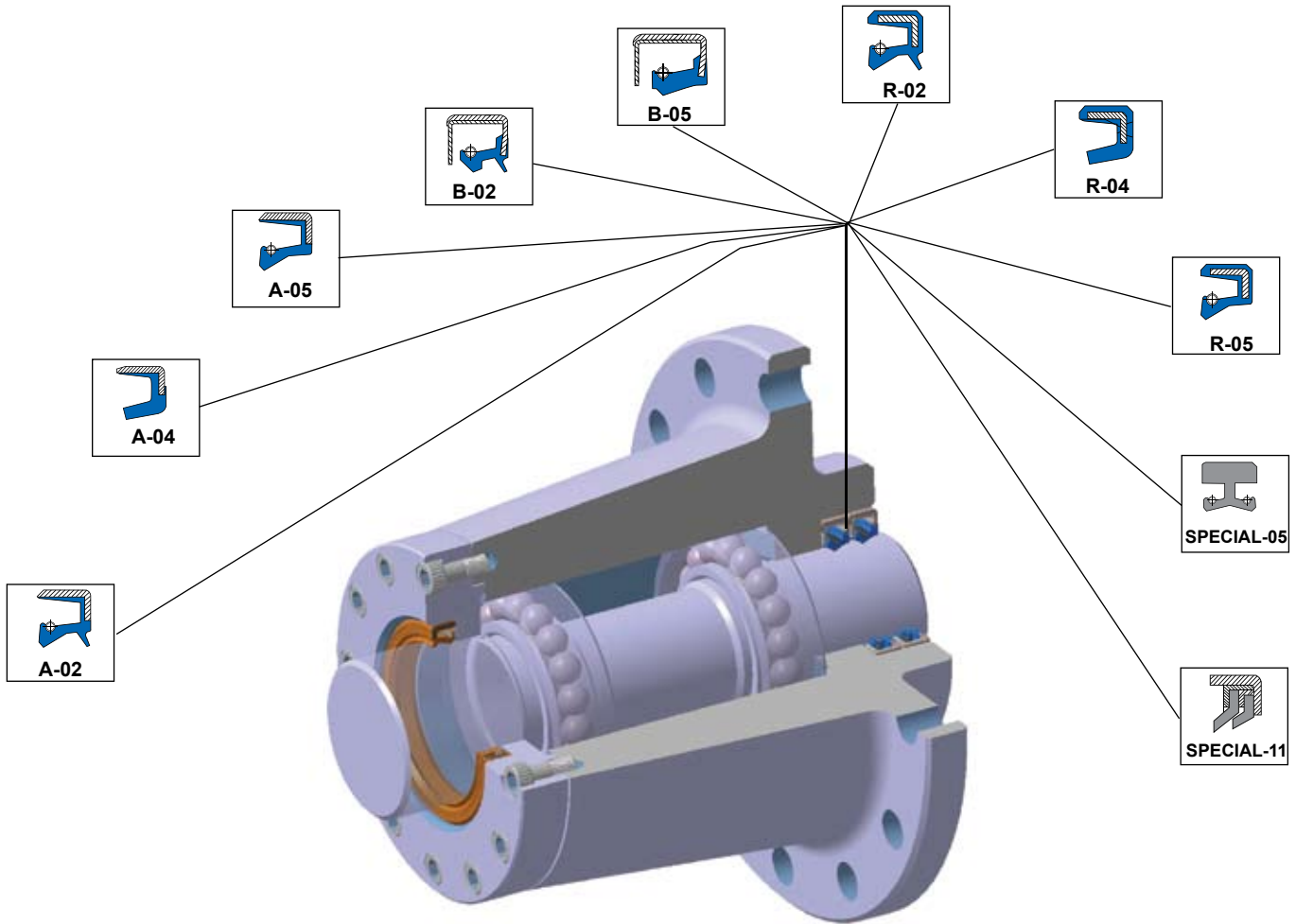

MODELO DE APLICAÇÃO:

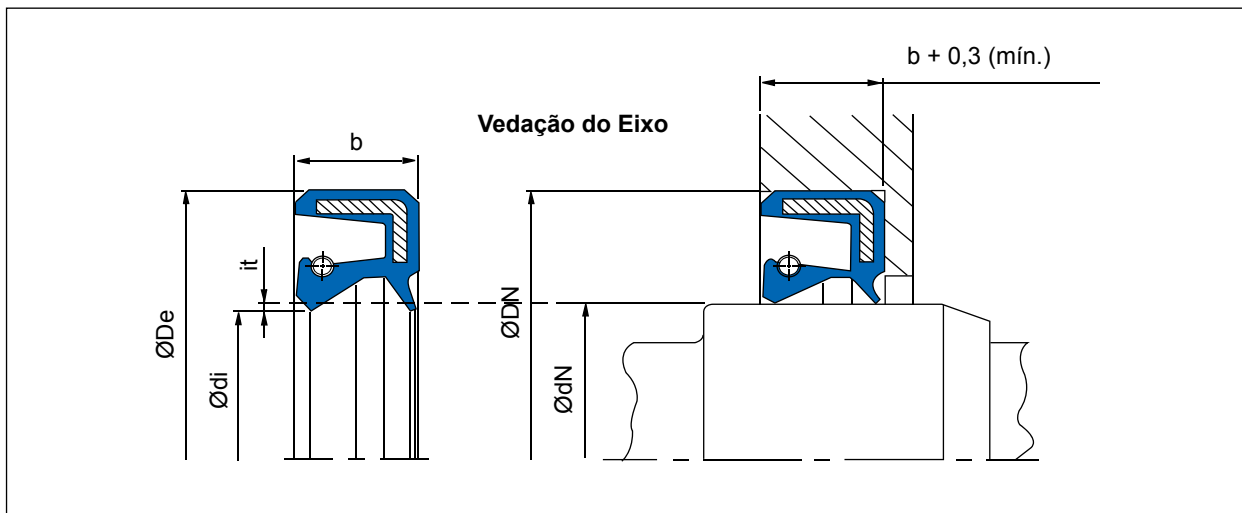

RETENTORES

Retentores

Seção 001



V'Rings











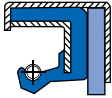





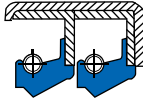







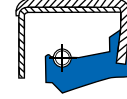
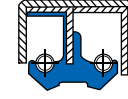

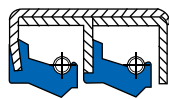
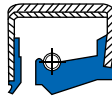

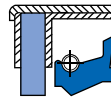

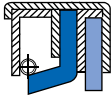
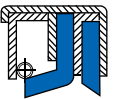
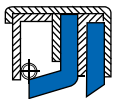

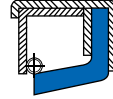
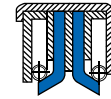
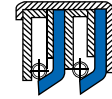
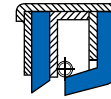
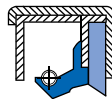
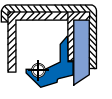



















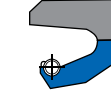
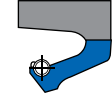
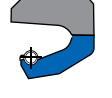
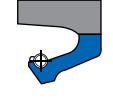
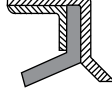
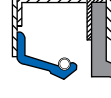
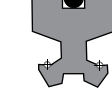
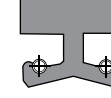

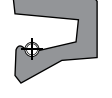
Seção 005

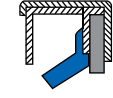
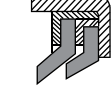
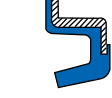

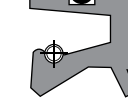
Ret. Rotary

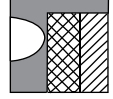
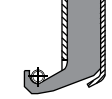
Seção 034

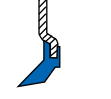

							
A-01	A-02	A-04	A-05	A-07	A-08	A-09	A-2B
							
A-5B	A-5S	B-01	B-02	B-03	B-04	B-05	B-07
							
B-08	B-09	B-12	B-13	B-21	B-2B	B-5B	C-01
							
C-02	C-03	C-04	C-05	C-07	C-09	C-12	D-02
							
D-03	D-12	DU-01	R-02	R-04	R-05	R-07	R-08
							
R-2R	R-2RB	R-2S	R-5R	R-5RB	R-5S	RB-02	RB-04
							
RB-05	RB-55	RBP-05	RBP-55	RL-02	RL-04	RL-05	RL-55
							
RLP-05	RLP-55	Special-01	Special-02	Special-03	Special-04	Special-05	Special-06
							
Special-07	Special-08	Special-09	Special-10	Special-11	Special-12	Special-13	Special-14
							
Special-15	Special-16	Special-17	Special-18	Special-19	Special-20		



Materiais

TABELA COM NOMENCLATURAS QUÍMICAS E COMERCIAIS PARA ALGUNS ELASTÔMEROS E MATERIAIS SINTÉTICOS

Descrição Química	Siglas	Nomenclatura CBV	Nomes Comerciais
Copolímero Acrilonitrila-Butadieno	NBR	Borracha Nitrílica	Perbunan, Hycar, Chemigum, Breon, Butakon, Europrene N, Butacril, Krynac, Paracril, Nipol, Nitriflex
Policloropreno	CR	Neoprene®	Neoprene, Baypren, Butaclor, Denka, Chloroprene
Poliacrílico	ACM	Acrílico-nitrílico	Cyanacryl, Europrene AR, Noxtite PA, Nipol AR
Copolímero Acrilato-Etileno	AEM	Vamac®	Vamac®
Borracha de Silicone	VMQ/PVMQ	Silicone	Silopren, Silastic, Silicone, Rhodorsil
Fluor elastômero	FPM	Viton	Viton®, Fluorel, Tecnoflon, Dai EI, Noxtite
Per Fluor elastômero	FFPM	Kalrez®	Kalrez®, Simriz, Chemraz
Poliuretano	AU/EU	PU	Vulkollan, Urepan, Desmopan, Adipren, Estane, Elastothane, Pellethane, Simputhan
Copolímero Epicloridrina-Óxido de Etileno	ECO	ECO	Epichlomer, Hydrin, Gechron
Copolímero Estireno-Butadieno	SBR	SBR	Buna Hüls, Buna SB, Europrene, Cariflex S, Solprene, Carom
Copolímero Etileno-Propileno-Dieno	EPDM	EPDM	Dutral, Keltan, Vistalon, Nordel, Epsyn, Buna AP, Royalene, Polysar EPDM
Copolímero Isobutileno-Isopreno	IIR	Borracha Butílica®	Enjay Butyl, Esso Butyl, Polysar Butyl
Polietileno Clorossulfonado	CSM	Hypalon®	Hypalon®

® Marca Registrada Du Pont

TABELA DE PROPRIEDADES FÍSICAS E MECÂNICAS

Elastômeros

Tabela de Propriedades (Algumas Matérias-primas)											
Designação	BR	SBR	IIR	BR	EPDM	CR	NBR	VMQ	CSM	AU	FPM
Densidade Específica (g/cm³)	0.93	0.94	0.92	0.91	0.86	1.23	1.40	1.40	1.20	1.05	1.86
Resistência à Abrasão	B/E	E	B	S	B	B	E	F	B-E	S	B
Resistência ao Rasgamento	E	B	B	B	B	E	B	F	B	E	F
Envelhecimento Térmico a 100°C	F	F	B	F	E	B	B	S	E	F	S
Temperatura de Trabalho máx (°C)	80	100	150	100	150	100	120	200	120	100	210
Temperatura de Transição Vítreas (°C)	-60	-50	-40	-60	-50	-45	-40	-30	-20	-30	-25
Impermeabilidade à Gases	B	B	S	B	B	B	B	R	E	R	E
Resistência a Intempéries	F	F	E	F	E	E	F	S	E	B	S
Resistência ao Ozônio	F	F	B	F	E	B	F	S	E	E	S
Resistência a Ácidos Diluídos	B	B	E	B	S	E	B	F	E	R	E
Resistência a Alcalis Diluídos	B	B	E	B	S	E	B	R	E	F	R
Resistência a Hidrocarbonetos Alifáticos	R	R	R	R	R	B	E	B	F	E	E
Resistência a Hidrocarbonetos Aromáticos	R	R	R	R	R	R	B	B	F	R	E

S = Superior

E = Excelente

B = Boa

R = Ruim

F = Fraco

RETENTOR COM CAPA EXTERNA DE ELASTÔMERO, LÁBIO DE VEDAÇÃO COM CARGA DE MOLA E LÁBIO DE PROTEÇÃO ANTI-POEIRA (MODELO: R-02).

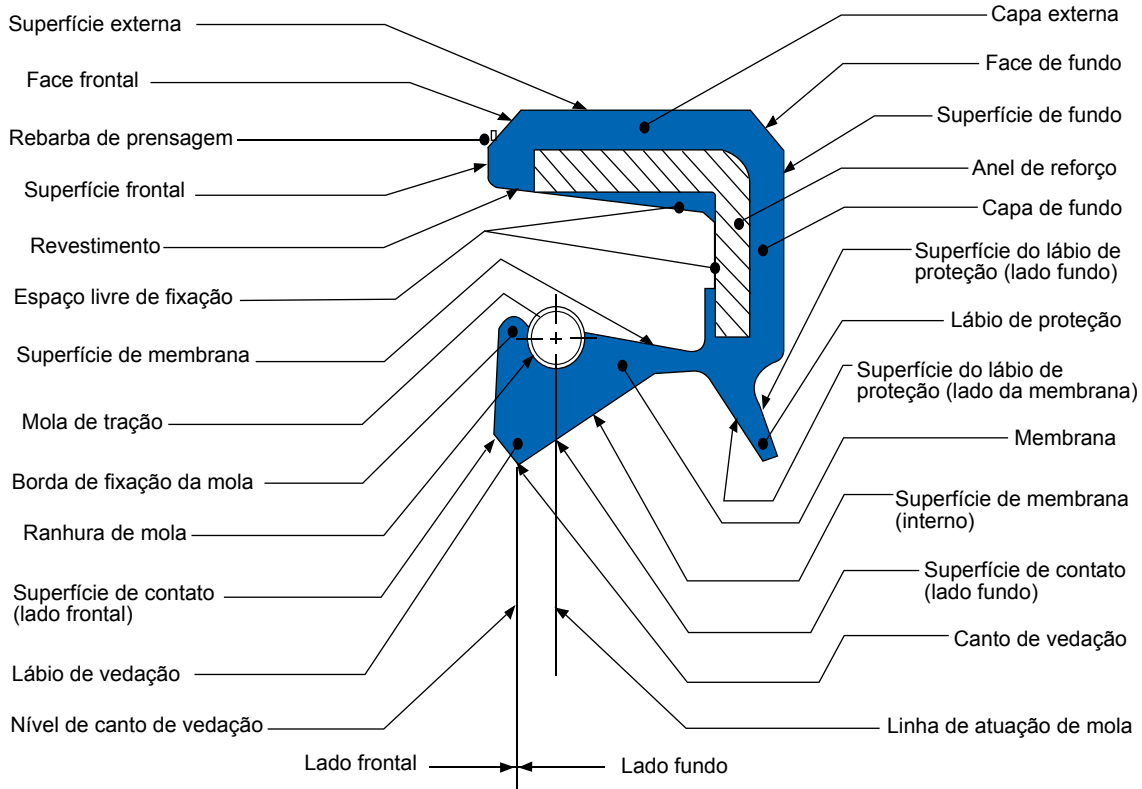

PRESSÃO PERMITIDA DO PRODUTO A SER VEDADO PARA RETENTORES COM ANEL DE SUPORTE E PARA O MODELO R-02P. DE ÓLEO DE MOTORES SAE 20.

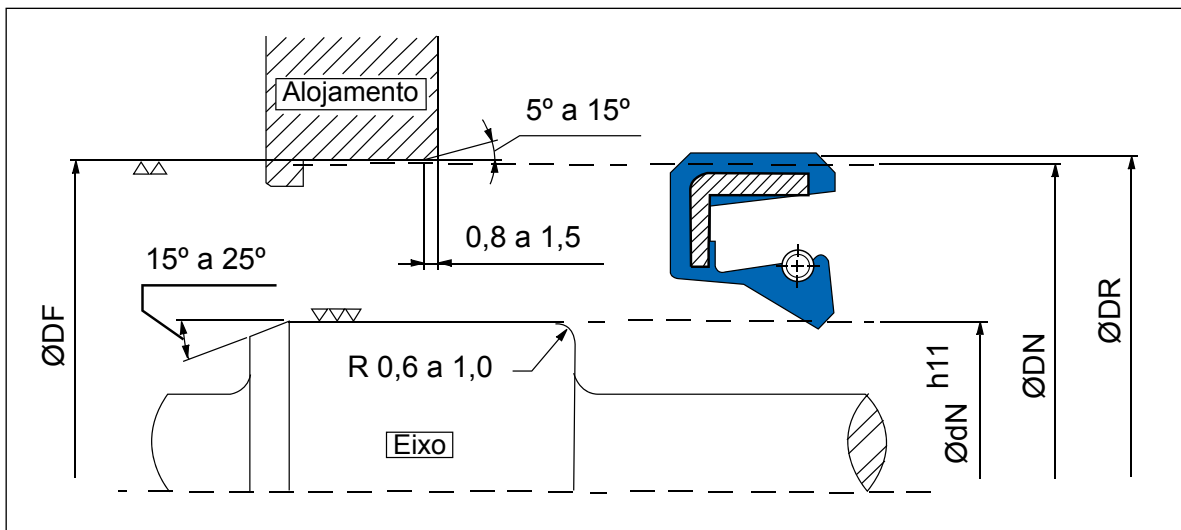



TABELA DE TOLERÂNCIAS:

Diâmetro do eixo dN (mm)			Interferência (I) = 2 x it	Diâmetro da mola	Diâmetro Externo DN (mm)		Tolerâncias (mm)	
Faixa	Maior / igual	menor			Maior / igual	menor	Caixa de metal	Revestido de Borracha
A	-	25	1,0 a 1,5	1,0	-	50	+0,20 +0,10	+0,30 +0,15
B	25	40	1,5 a 2,0	1,5	50	80	+0,23 +0,13	+0,35 +0,20
C	40	80	2,0 a 2,5	2,0	80	120	+0,25 +0,15	+0,35 +0,20
D	80	120	2,5 a 3,0	2,5	120	180	+0,28 +0,18	+0,45 +0,25
E	120	180	3,0 a 3,5	3,0	180	300	+0,30 +0,20	+0,45 +0,25
F	180	250	3,5 a 4,0	3,5	300	500	+0,35 +0,23	+0,55 +0,30
G	250	350	4,0 a 4,5	4,0	500	-	+0,38 +0,25	+0,60 +0,35
H	350	450	4,5 a 5,0	4,5				
I	450	600	5,0 a 5,5	4,5				
J	600	800	5,5 a 6,0	5,0				
K	800	-	6,0 a 7,0	5,5				

Altura (b)		Tolerâncias (mm)
Maior / igual	Menor	
-	4	±0,20
4	12	±0,30
12	20	±0,40
20	-	±0,50

Di = Diâmetro interno do retentor
De = Diâmetro externo do retentor
dN = Diâmetro do eixo
DN = Diâmetro externo do alojamento
it = 1/2 interferência
I = Interferência
Di = dN - 2 . it

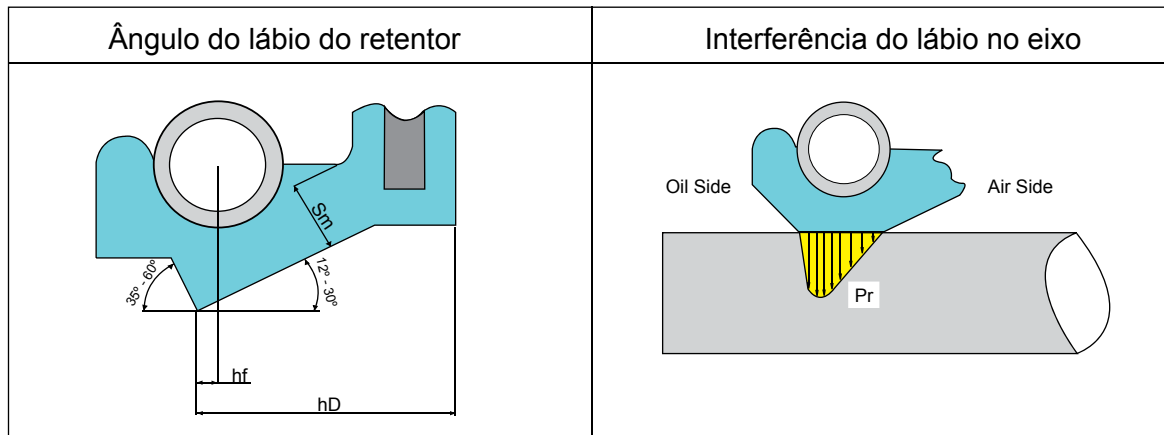
Tolerância de DF e DR e Interferência Resultante					
		Retentor tipo R-05 ou R-02		Retentor tipo B-05 ou A-05	
ØDN	Tol. DF (H8)	Tol. DR	Interferência Resultante	Tol. DR	Interferência Resultante
de 10 a 18	0	,+ 0,30	,+0,300	,+0,20	,+0,200
	. + 0,027	,+0,15	,+0,123	,+0,10	,+0,073
de 18 a 30	0	,+0,30	,+0,300	,+0,20	,+0,200
	. + 0,033	,+0,15	,+0,117	,+0,10	,+0,067
de 30 a 50	0	,+0,35	,+0,300	,+0,20	,+0,200
	. + 0,039	,+0,20	,+0,111	,+0,10	,+0,061
de 50 a 80	0	,+0,35	,+0,350	,+0,23	,+0,230
	. +0,046	,0,20	,+0,154	,+0,13	,+0,084
de 80 a 120	0	,+0,35	,+0,350	,+0,25	,+0,250
	. +0,054	,+0,20	,+0,146	,+0,15	,+0,096
de 120 a 180	0	,+0,45	,+0,450	,+0,28	,+0,280
	. +0,063	,+0,25	,+0,187	,+0,18	,+0,117
de 180 a 300	0	,+0,45	,+0,450	,+0,30	,+0,300
	. +0,072	,0,25	,+0,178	,+0,20	,+0,128

Exemplos de utilização		
Cálculo de DF = $\varnothing DN + Tol. DF$	Ex: DF _{mín} = 65 + 0,000 = 65,000
		Ex: DF _{máx} = 65 + 0,046 = 65,046
Cálculo de DR = $\varnothing DN + Tol. DF$	Ex: DR _{mín} = 65 + 0,200 = 65,200
		Ex: DR _{máx} = 65 + 0,350 = 65,350
Cálculo da Interferência Resultante:		
Int.máx = DR _{máx} - DF _{mín}	Ex: Int. máx = 65,350 - 65,000 = 0,350
Int.mín = DR _{mín} - DF _{máx}	Ex: Int. mín = 65,200 - 65,046 = 0,154

O acabamento da superfície do furo poderá ser obtido por usinagem fina com rugosidade de até Rt 25µ. Desse modo será garantida uma boa retenção e estanqueidade entre o retentor e o alojamento.

Para se obter uma boa condição de montagem do retentor, deve ser previsto um chanfro de entrada no início do alojamento com inclinação de ordem de 5° e 15°, numa profundidade de 0,8mm mínimo. Os cantos desta superfície deverão estar livres de rebarbas de usinagem.

EXECUÇÃO DO EIXO DE TRABALHO:

Para o diâmetro do eixo dN deverá ser prevista a tolerância conforme recomendação da Norma DIN 3761, ISO h11

Retentores são utilizados para a vedação de eixos rotativos, especialmente na construção de máquinas e aparelhos, bem como na indústria automobilística.

Os produtos a serem vedados podem ser pastosos, líquidos ou em forma de gás. Na maioria das vezes trata-se da vedação de óleos e graxas de lubrificação.

AS PRINCIPAIS CARACTERÍSTICAS SÃO:

- > a capa externa cilíndrica de elastômeros ou de metal. Existem formas construtivas com a capa externa de elastômeros que são constituídas de uma chapa metálica de reforço, as formas construtivas com chapa externa metálica são fornecidas estampadas ou retificadas na circunferência externa.
- > o lábio de vedação com carga de mola. Ela tem a tarefa de garantir a vedação dinâmica e estática contra o eixo girando ou parado,
- > quando necessário, um lábio de proteção adicional para evitar a penetração externa de poeira e sujeira.

ALÉM DA EXIGÊNCIA PRINCIPAL, PARA UM BOM EFEITO DE VEDAÇÃO, EXIGE-SE MAIS PARA OS RETENTORES:

- > Segurança de funcionamento;
- > Longa vida útil;
- > Compatibilidade com os produtos a serem vedados;
- > Pouco atrito.

NORMAS:

A base da padronização é a norma DIN 3760 com os pontos principais:

1. Área de validade
2. Medidas e Descrições
3. Matérias-Prima e Proteção de superfície.
4. Marcação.
5. Emprego.
6. Diretrizes para montagem.
7. Explicações.

INFORMAÇÕES DECISIVA PARA SELEÇÃO DO VEDADOR DO EIXO:

- Produtos a serem vedados
- Velocidade na circunferência.(RPM)
- Temperatura (°C)
- Pressão
- Movimento Radial
- Lubrificante

MATERIAIS ELASTOMÉRICOS:

A vedação se dá por meio da interferência do lábio elastomérico sobre o eixo. Esta condição de trabalho provoca o aparecimento de uma força de atrito na área do lábio com a direção do movimento do eixo e sentido contrário ao mesmo.

A força de atrito e a velocidade periférica do eixo tornam-se responsáveis por uma geração de calor localizada na área de contato do lábio, que tende a promover a degeneração do material e o desgaste do labio de vedação.

A contenção destes efeitos é conseguida primordialmente pela escolha correta do material elastômero. É de suma importância que esta escolha seja definida em conjunto com o fabricante de vedador, pois há série de fatores de projeto que devem ser igualmente considerados para conferir uma vida prolongada ao vedador.

Na tabela abaixo, estão mostradas as várias qualidades de elastômeros e recomendações genéricas de uso para os diferentes fluidos e limites de temperaturas de trabalho.

Código do elastômero, de acordo com as Normas ISO 1629 e DIN 3761	Tipo de Borracha	Limite de Temperatura mínima de trabalho (°C)	Oleos para motor	Oleo para Caixa de Mudanças	Oleos Hipoides	Oleos para Transmissão Automática(A.T.F.)	Graxa	Gasolina + Oleo Motor 2T	Alcool + Aditivos	Aplicações Gerais
			Limites de Temperatura máxima de trabalho (°C)							
NBR	Nitrílica	-35	110	110	110	120	90	100	100	Material normalmente utilizado para máquinas e equipamentos industriais. Muito utilizado na indústria automotiva para aplicações gerais.
ACM	Poliacrílica	-15	130	120	120	130	-	-	-	Material largamente utilizado para motores e transmissões na indústria automobilística.
MVQ	Silicone	-50	150	-	-	130	-	-	-	Material usualmente empregado em motores de elevado desempenho e em conversores de torque de transmissões automáticas.
FPM	Fluorelastômetro	-30	150	150	150	150	-	125	125	Material empregado em motores e transmissões, altamente solicitados.

Na figura abaixo é mostrado um abado que indica os limites de velocidade periférica do eixo para cada material, prevendo que haja uma boa lubrificação do lábio e também que a pressão interna da máquina seja praticamente igual a pressão externa.

Estas considerações para escolha do material elastômero devem ser consideradas somente como uma orientação geral. Recomendamos portanto, que para cada nova aplicação de vedador, o projeto seja previamente discutido com a Engenharia de Produtos.

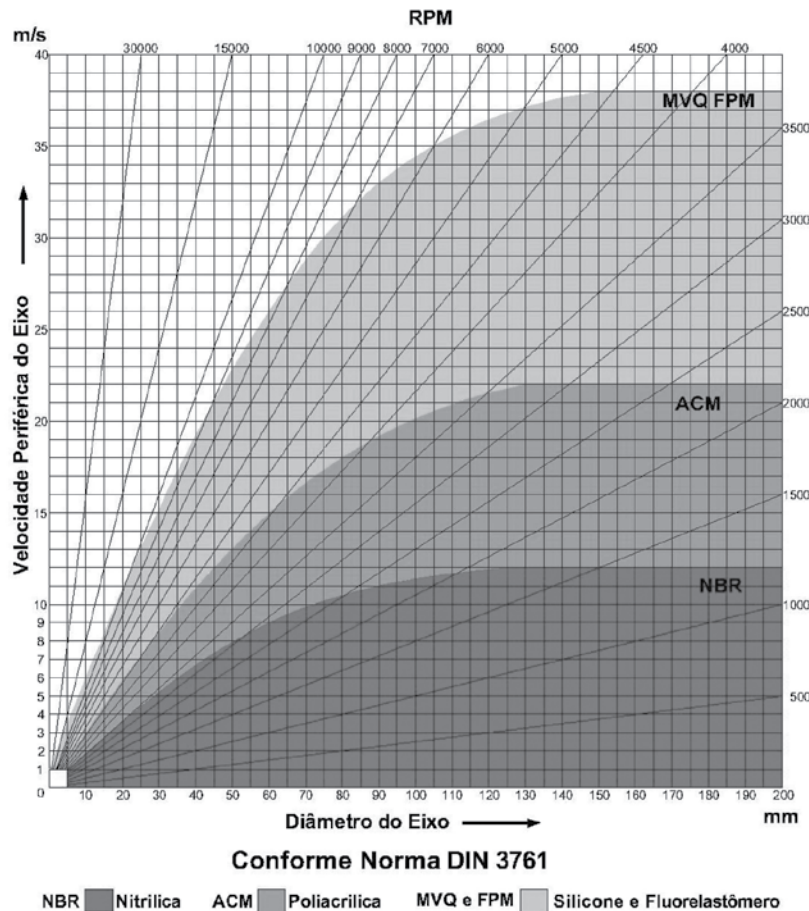

Eixo	Aloj.	Alt.	Modelo	Código CBV	T. M.	Conversão
3.00	6.50	2.50	R-04	18658	(1)	
3.00	10.00	6.00	R-05	10003	(1)	
4.50	9.60	3.50	R-04	18660	(1)	
5.00	14.50	4.50	R-05	49248	(1)	03254BR
6.00	10.00	2.50	R-04	38388	(1)	02515GR
6.00	12.00	2.00	A-04	10000	(1)	
6.00	16.00	6.50	R-02	10012	(1)	02873BRG
6.00	16.00	7.00	A-05	10014	(1)	
6.00	16.00	7.00	R-05	10013	(1)	
6.00	18.00	8.00	R-07	18671	(1)	
6.00	19.00	6.00	R-05	10015	(1)	
6.40	16.05	6.40	A-05	10021	(1)	00807BA
6.40	19.10	6.40	R-05	10002	(1)	01685BR
6.50	14.50	7.00	R-02	10025	(1)	02306BRG
6.80	22.00	7.00	R-02	10026	(1)	02166BRG
7.00	16.00	7.00	A-05	10027	(1)	02358BA
7.00	16.00	7.00	R-05	10028	(1)	
7.00	22.00	12.00	R-05	10033	(1)	
7.35	22.25	5.20	B-05	46897	(7)	
7.50	18.00	7.00	R-05	38865	(2)	
7.80	13.80	3.60	R-04	18681	(1)	02198GR
7.80	14.10	3.60	A-04	49249	(1)	01984GA
7.80	14.60	4.80	A-04	39142	(2)	00482GAF
7.94	19.05	6.35	A-05	10039	(1)	
7.94	19.05	6.35	R-02	52059	(1)	
7.94	28.58	9.53	R-05	10047	(1)	
8.00	12.00	3.00	R-04	18692	(1)	
8.00	14.00	3.00	R-02	10049	(1)	02536BRG
8.00	14.00	3.00	R-05	49250	(1)	02536BR
8.00	14.00	3.00	R-05	39143	(2)	02495BRF
8.00	14.70	4.80	A-04	49361	(2)	
8.00	15.00	3.00	R-04	38389	(6)	02491GR
8.00	15.00	5.50	R-05	10051	(1)	02762BR
8.00	16.00	7.00	A-05	40251	(5)	02013BAP
8.00	16.00	7.00	A-05	38867	(2)	
8.00	16.00	7.00	R-05	10052	(1)	
8.00	16.00	7.00	R-05	38866	(2)	
8.00	17.45	8.00	A-05	10053	(1)	00198BA
8.00	18.00	5.00	R-02	10054	(1)	02163BRG
8.00	18.00	5.00	R-05	10055	(1)	01423BR
8.00	20.00	8.00	R-05	10059	(1)	
8.00	22.00	3.00	A-04	10060	(1)	
8.00	22.00	6.50	R-05	10061	(1)	
8.00	22.00	7.00	A-05	10063	(1)	
8.00	22.00	7.00	R-05	10062	(1)	
8.00	22.00	8.00	A-05	53825	(1)	
8.00	22.00	8.00	R-05	10065	(1)	01587BR
8.00	22.00	8.00	R-05	47792	(2)	
8.00	28.00	9.00	R-02	18878	(1)	
8.50	16.00	6.50	R-05	10069	(1)	00998BR
9.00	16.00	3.00	A-04	38868	(2)	
9.00	16.00	4.00	R-04	51303	(1)	
9.00	22.00	7.00	R-05	10078	(1)	
9.00	24.00	7.00	R-05	10080	(1)	
9.00	26.00	7.00	R-05	10081	(1)	
9.40	21.40	5.00	A-04	18704	(1)	02248GA

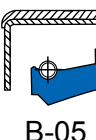
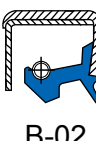

Eixo	Aloj.	Alt.	Modelo	Código CBV	T. M.	Conversão
9.40	21.40	5.00	R-04	81757	(3)	
9.40	21.40	5.00	R-04	81756	(4)	
9.50	19.05	6.00	R-05	10086	(1)	
9.50	19.20	7.00	R-05	10085	(1)	01093BR
9.50	25.35	9.50	B-05	10093	(1)	00089B
9.80	20.30	4.80	R-05	10103	(1)	
10.00	14.00	3.00	A-04	18708	(1)	02135GA
10.00	16.00	4.00	A-04	18710	(1)	
10.00	17.00	4.00	R-04	18713	(1)	
10.00	17.00	5.00	R-04	18714	(1)	
10.00	18.00	5.00	R-05	53827	(1)	
10.00	18.00	6.00	R-05	10107	(1)	
10.00	19.00	6.50	R-05	10111	(1)	02171BR
10.00	19.00	7.00	R-05	10114	(1)	
10.00	19.00	7.00	R-05	51311	(2)	
10.00	20.00	4.00	R-05	10115	(1)	
10.00	21.00	5.00	R-05	10117	(1)	03005BR
10.00	22.00	6.50	R-5R	10119	(1)	
10.00	22.00	7.00	A-05	53828	(1)	
10.00	22.00	7.00	R-05	10120	(1)	01672BR
10.00	22.00	7.00	R-05	40252	(5)	01904BRP
10.00	22.00	7.00	R-05	56602	(2)	
10.00	22.00	8.00	A-05	10125	(1)	
10.00	22.00	8.00	R-02	10122	(1)	01672 BRG
10.00	22.00	8.00	R-02	38869	(2)	01672 BRG
10.00	24.00	7.00	A-05	10128	(1)	
10.00	24.00	7.00	R-05	10129	(1)	
10.00	24.00	8.00	R-05	50779	(1)	
10.00	25.00	6.00	R-02	54409	(2)	
10.00	26.00	7.00	R-05	10133	(1)	
10.00	26.00	8.00	R-05	54691	(2)	
10.00	28.00	4.20	R-04	55908	(1)	
10.00	30.00	7.00	A-05	10139	(1)	00764BA
10.00	30.00	7.00	R-02	47247	(1)	
10.30	16.00	4.00	A-04	18717	(1)	02001GA
10.80	22.20	5.40	R-05	10148	(1)	01067BR
11.00	17.00	4.00	R-05	10151	(1)	01737BR
11.00	17.00	4.00	R-05	38870	(2)	02523BRF
11.00	19.00	5.00	A-05	56722	(2)	
11.00	20.00	6.00	R-05	54149	(1)	
11.00	21.00	7.00	A-02	38871	(2)	02787BAGF
11.00	22.00	8.00	R-05	10156	(1)	
11.00	23.00	7.00	A-05	10157	(1)	
11.00	23.00	7.00	R-05	38872	(2)	
11.00	24.00	7.00	R-05	10158	(1)	
11.00	25.00	7.00	R-02	10264	(1)	
11.00	26.00	7.00	R-05	10160	(1)	
11.10	22.20	6.50	R-02	10168	(1)	02474BRG
11.10	25.40	6.00	R-05	10161	(1)	01479BR
11.11	25.40	9.53	R-05	10176	(1)	
11.11	31.75	9.53	R-05	10182	(1)	
11.60	24.00	10.00	R-02	10225	(5)	07408BRGP
11.91	28.58	9.53	B-05	10189	(1)	
12.00	16.00	3.00	A-04	18733	(1)	
12.00	16.00	3.00	A-04	51259	(2)	
12.00	16.00	3.00	R-04	54805	(1)	

T. M. = Tipo de Material

(1) 70 NBR (2) 70 FPM (3) 80 NBR (4) 80 FPM (5) 70 ACM (6) 70 CR (7) 63 PG (8) 70 VMQ (9) 70 EPDM (10) 90 PU

Eixo	Aloj.	Alt.	Modelo	Código CBV	T. M.	Conversão
12.00	18.00	3.00	R-04	10192	(1)	02638GR
12.00	18.00	4.00	R-04	10194	(1)	
12.00	18.20	6.00	A-05	10195	(1)	
12.00	19.00	5.00	R-05	18735	(1)	05148BR
12.00	19.00	6.00	A-04	18734	(1)	
12.00	20.00	5.00	R-05	10200	(1)	
12.00	20.00	7.00	R-05	10217	(1)	
12.00	21.00	4.00	R-05	10202	(1)	03255BR
12.00	22.00	4.00	R-05	10203	(1)	
12.00	22.00	4.50	R-05	10204	(1)	
12.00	22.00	5.00	A-04	18736	(1)	
12.00	22.00	5.00	R-02	18737	(1)	02535BRG
12.00	22.00	5.00	R-05	10205	(1)	
12.00	22.00	5.00	R-05	38873	(2)	
12.00	22.00	6.00	R-2S	10206	(1)	
12.00	22.00	7.00	A-02	53751	(1)	
12.00	22.00	7.00	A-04	10210	(1)	
12.00	22.00	7.00	A-05	10209	(1)	00289BA
12.00	22.00	7.00	R-02	10208	(1)	
12.00	22.00	7.00	R-02	38874	(2)	
12.00	22.00	7.00	R-05	10211	(1)	00289BR
12.00	22.00	7.00	R-05	38875	(2)	
12.00	22.00	8.00	B-05	10214	(1)	
12.00	22.00	8.00	R-02	54871	(1)	
12.00	22.00	8.00	R-05	10213	(1)	
12.00	22.30	7.00	R-05	10212	(1)	
12.00	24.00	6.00	R-02	54801	(1)	
12.00	24.00	7.00	A-05	10219	(1)	
12.00	24.00	7.00	R-05	48599	(1)	
12.00	25.00	6.00	R-05	10222	(1)	
12.00	25.00	7.00	R-02	52233	(1)	
12.00	25.00	7.00	R-05	10178	(1)	
12.00	25.00	8.00	A-05	10224	(1)	
12.00	25.00	8.00	R-05	10223	(1)	
12.00	26.00	8.00	R-05	10226	(1)	
12.00	28.00	4.20	R-04	55909	(1)	
12.00	28.00	7.00	R-05	55021	(2)	
12.00	28.05	8.00	A-02	10001	(1)	02792BAG
12.00	28.10	7.00	R-02	55700	(1)	01420BRG
12.00	28.10	7.00	R-05	10228	(1)	01420BR
12.00	30.00	7.00	R-05	10232	(1)	
12.00	30.00	7.00	R-05	10233	(1)	
12.00	30.00	8.00	R-02	10235	(1)	
12.00	30.00	10.00	R-05	10237	(1)	
12.00	32.00	5.00	A-05	10240	(1)	
12.00	32.00	7.00	A-05	18729	(1)	01445BA
12.00	32.00	7.00	R-02	56718	(1)	
12.00	32.00	7.00	R-05	10242	(1)	
12.50	20.00	5.00	R-05	38876	(2)	02360BRF
12.50	25.00	8.00	R-02	49252	(1)	03250BRG
12.60	21.40	5.00	A-04	18749	(1)	02249GA
12.60	21.40	5.00	R-04	81754	(3)	
12.60	21.40	5.00	R-04	81753	(4)	
12.68	22.20	5.20	B-05	46370	(7)	
12.70	19.45	7.14	R-05	10196	(1)	02689BAG
12.70	20.64	6.35	R-05	10250	(1)	

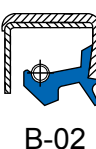

Eixo	Aloj.	Alt.	Modelo	Código CBV	T. M.	Conversão
12.70	22.20	7.00	A-05	10255	(1)	
12.70	22.20	8.00	A-05	40253	(5)	02343BAP
12.70	22.35	8.00	R-05	10257	(1)	01559BR
12.70	25.15	6.40	A-05	10259	(1)	
12.70	25.28	6.35	R-05	10261	(1)	
12.70	25.30	9.50	B-05	10272	(1)	01508B
12.70	25.35	6.40	A-04	18755	(1)	00981GA
12.70	25.35	6.40	A-05	10265	(1)	01966BA
12.70	25.40	6.35	A-02	10262	(1)	
12.70	25.40	6.35	R-02	10263	(1)	
12.70	25.40	7.14	R-05	10268	(1)	
12.70	25.40	9.50	R-05	10273	(1)	00129BR
12.70	25.40	9.53	R-05	10271	(1)	
12.70	25.40	9.53	R-05	38877	(2)	
12.70	28.50	9.50	B-05	10279	(1)	00311B
12.70	28.55	6.50	A-05	10275	(1)	01957BA
12.70	28.58	9.53	R-05	10280	(1)	
12.70	28.58	12.70	B-02	10281	(1)	
12.70	28.60	6.40	R-05	38878	(2)	
12.70	30.00	8.00	R-05	10276	(1)	01097BR
12.70	31.75	6.35	A-04	18758	(1)	
12.70	34.93	6.35	A-04	18759	(1)	
13.00	19.00	4.00	A-02	10296	(1)	02942BAG
13.00	20.00	5.00	A-04	10295	(1)	
13.00	22.00	5.00	A-05	10298	(1)	
13.00	22.00	5.00	R-05	10300	(1)	
13.00	22.50	7.00	R-05	38534	(8)	
13.00	23.00	6.00	A-05	10302	(1)	
13.00	25.00	5.00	R-05	10303	(1)	
13.00	26.00	7.00	R-02	10306	(1)	02373BRG
13.00	26.00	7.00	R-05	10307	(1)	
13.00	26.00	9.00	R-02	10309	(1)	01074BRG
13.00	26.00	9.00	R-04	18763	(1)	
13.00	30.00	8.00	R-05	10313	(1)	01097BR
13.49	31.75	7.94	A-05	10321	(1)	
13.50	20.00	4.00	A-02	10318	(1)	02943BAG
13.50	24.00	7.00	R-02	50899	(1)	
14.00	20.00	3.00	R-04	18764	(1)	
14.00	20.00	3.50	A-05	10322	(1)	02025BA
14.00	20.00	5.00	R-04	18765	(1)	
14.00	20.00	7.00	R-02	56520	(1)	
14.00	22.00	4.00	R-02	40254	(5)	02569BRGP
14.00	22.00	4.00	R-05	10324	(1)	
14.00	22.00	5.00	R-05	20247	(1)	03252BR
14.00	23.00	7.00	R-05	48602	(1)	
14.00	23.90	6.00	A-04	18768	(1)	01717GA
14.00	24.00	6.00	R-02	10327	(1)	02162BRG
14.00	24.00	7.00	A-02	10329	(1)	01389BAG
14.00	24.00	7.00	R-02	10331	(1)	
14.00	24.60	7.00	R-05	10332	(1)	
14.00	25.00	5.00	R-04	18769	(1)	
14.00	25.00	5.00	R-05	10335	(1)	
14.00	28.00	7.00	R-02	10339	(1)	02308BRG
14.00	32.00	10.00	R-05	10349	(1)	01875BR
14.00	35.00	7.00	R-05	10350	(1)	
14.29	31.75	9.53	A-05	10364	(1)	

T. M. = Tipo de Material

(1) 70 NBR (2) 70 FPM (3) 80 NBR (4) 80 FPM (5) 70 ACM (6) 70 CR (7) 63 PG (8) 70 VMQ (9) 70 EPDM (10) 90 PU

Eixo	Aloj.	Alt.	Modelo	Código CBV	T. M.	Conversão
14.30	22.00	3.90	R-04	18781	(1)	01977GR
14.30	23.95	7.00	A-05	10334	(1)	01835BA
14.30	23.95	7.00	R-05	14993	(1)	01835BR
14.30	25.40	9.50	B-05	10354	(1)	00716B
14.30	28.50	6.40	R-05	10356	(1)	00293BR
14.30	28.50	9.50	B-05	10363	(1)	00541B
14.30	39.55	6.30	A-02	10370	(1)	02334BAG
14.50	35.00	7.00	B-02	18782	(1)	
14.73	30.00	7.00	A-05	10372	(1)	
15.00	21.00	3.00	R-04	18784	(1)	02589GR
15.00	21.00	4.00	A-02	10373	(1)	02130BAG
15.00	22.00	3.90	R-04	18785	(1)	02441GRG
15.00	22.00	7.00	R-05	53829	(1)	
15.00	23.00	3.00	R-04	10376	(1)	02639GR
15.00	23.00	4.00	R-02	46921	(1)	
15.00	23.00	6.00	R-02	10393	(1)	
15.00	24.00	5.00	A-05	51390	(1)	
15.00	24.00	5.00	R-02	55672	(2)	
15.00	24.00	7.00	A-02	10378	(1)	01929BAG
15.00	24.00	7.00	A-05	10379	(1)	01929BA
15.00	24.00	7.00	A-07	18787	(1)	
15.00	24.00	7.00	R-02	10380	(1)	01929BRG
15.00	24.00	7.00	R-02	54629	(2)	01929BRGF
15.00	24.00	7.00	R-05	10382	(1)	00790BR
15.00	24.00	7.00	R-07	10383	(1)	
15.00	24.00	7.40	A-05	10381	(1)	01816BA
15.00	24.00	10.00	R-05	10388	(1)	
15.00	25.00	5.00	A-05	10387	(1)	
15.00	25.00	5.00	R-02	10384	(1)	
15.00	25.00	5.00	R-05	10386	(1)	
15.00	25.00	7.00	R-02	10390	(1)	02454BRG
15.00	25.00	7.00	R-05	10389	(1)	02309BR
15.00	25.00	7.00	R-05	40255	(5)	02309BRP
15.00	26.00	4.00	A-02	10392	(1)	
15.00	26.00	6.00	A-02	10394	(1)	02279BAG
15.00	26.00	7.00	A-05	10396	(1)	
15.00	27.00	7.00	R-05	10398	(1)	
15.00	28.00	5.00	R-05	56795	(1)	
15.00	28.00	7.00	A-05	10399	(1)	00916BA
15.00	28.00	7.00	R-05	10400	(1)	
15.00	28.00	9.00	R-05	10403	(1)	
15.00	28.55	8.00	B-05	10414	(1)	01076B
15.00	29.60	4.00	A-02	10405	(1)	
15.00	30.00	4.50	R-05	18793	(1)	
15.00	30.00	5.00	A-04	18794	(1)	00515GA
15.00	30.00	5.00	A-05	10406	(1)	
15.00	30.00	6.00	A-02	40256	(5)	01915BAGP
15.00	30.00	7.00	A-02	10408	(1)	01846BAG
15.00	30.00	7.00	R-02	10409	(1)	
15.00	30.00	7.00	R-05	10410	(1)	01677BR
15.00	30.00	8.00	A-05	10413	(1)	00766BA
15.00	30.00	10.00	B-05	10418	(1)	
15.00	30.00	10.00	R-02	57047	(1)	
15.00	30.00	10.00	R-05	10419	(1)	01348BR
15.00	32.00	7.00	R-05	10422	(1)	01907BR
15.00	35.00	6.00	A-02	56575	(4)	

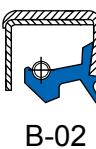

Eixo	Aloj.	Alt.	Modelo	Código CBV	T. M.	Conversão
15.00	35.00	7.00	A-02	10427	(1)	01959BAG
15.00	35.00	7.00	R-02	11362	(1)	
15.00	35.00	7.00	R-05	10425	(1)	01058BR
15.00	35.00	8.00	R-05	10431	(1)	
15.00	35.00	10.00	A-05	10435	(1)	
15.00	35.00	10.00	R-02	10432	(1)	01051BRG
15.00	35.10	10.00	R-05	10433	(1)	01051BR
15.00	40.00	10.00	R-05	10438	(1)	
15.00	42.00	10.00	R-05	10441	(1)	
15.80	25.40	3.50	R-04	10449	(1)	
15.88	22.23	3.18	A-04	18802	(1)	
15.88	23.81	4.76	R-04	18805	(1)	
15.88	28.58	6.35	R-05	10458	(1)	
15.88	28.58	7.94	A-05	10462	(1)	
15.88	31.75	6.35	R-05	39144	(2)	
15.88	31.75	7.54	R-05	10475	(1)	
15.88	31.75	7.94	B-05	10476	(1)	
15.90	22.20	4.30	A-02	10450	(1)	02335BAG
15.90	23.80	4.80	A-04	18804	(1)	00119GA
15.90	25.35	6.40	A-05	10455	(1)	01175BA
15.90	25.40	4.50	R-05	10488	(1)	00286BR
15.90	26.93	5.50	R-02	10490	(1)	
15.90	28.50	7.00	R-05	10492	(1)	01493BR
15.90	28.55	9.50	B-05	49253	(1)	00156B
15.90	28.55	9.50	R-05	10466	(1)	00156BR
15.90	28.55	9.50	R-07	10493	(1)	00156BRO
15.90	30.00	6.00	A-02	20225	(1)	01934BAG
15.90	30.30	4.50	R-04	18814	(1)	01700GR
15.90	35.00	10.00	A-05	10534	(1)	00375BA
16.00	22.00	3.00	A-04	46909	(6)	02492GA
16.00	22.00	3.00	R-04	38390	(6)	02492GR
16.00	22.00	4.00	A-04	18826	(1)	02492GR
16.00	22.10	6.40	A-02	10451	(1)	01576BAG
16.00	24.00	3.00	A-04	18829	(1)	
16.00	24.00	4.00	A-04	18830	(1)	
16.00	24.00	4.00	A-05	55038	(2)	
16.00	24.00	4.00	R-02	52120	(2)	
16.00	24.00	4.00	R-05	10491	(1)	
16.00	24.00	7.00	A-02	10497	(1)	
16.00	24.00	7.00	A-04	18831	(1)	
16.00	24.00	7.00	A-05	10498	(1)	
16.00	24.00	7.00	R-02	10496	(1)	02176BRG
16.00	25.00	4.00	R-02	50900	(1)	
16.00	26.00	6.00	R-02	57331	(1)	
16.00	26.00	8.00	R-02	52019	(1)	
16.00	28.00	3.00	R-05	10502	(1)	
16.00	28.00	7.00	A-05	10504	(1)	00980BA
16.00	28.00	7.00	R-02	10503	(1)	02310BRG
16.00	28.00	7.00	R-02	38882	(2)	
16.00	29.00	7.00	R-05	10510	(1)	
16.00	29.00	10.00	R-05	38535	(8)	
16.00	30.00	6.40	A-05	10512	(1)	01817BA
16.00	30.00	7.00	R-05	54150	(1)	
16.00	30.00	8.00	A-02	10514	(1)	
16.00	30.00	10.00	R-02	10518	(1)	
16.00	30.00	10.00	R-02	55671	(4)	

T. M. = Tipo de Material

(1) 70 NBR (2) 70 FPM (3) 80 NBR (4) 80 FPM (5) 70 ACM (6) 70 CR (7) 63 PG (8) 70 VMQ (9) 70 EPDM (10) 90 PU

Eixo	Aloj.	Alt.	Modelo	Código CBV	T. M.	Conversão
16.00	30.00	10.00	R-05	10520	(1)	00795BR
16.00	31.00	4.00	R-05	10524	(1)	
16.00	32.00	6.00	R-05	50693	(1)	
16.00	32.00	7.00	A-05	10522	(1)	
16.00	32.00	7.00	R-05	10525	(1)	00796BR
16.00	32.00	9.00	A-02	47925	(1)	
16.00	32.30	10.00	R-05	10528	(1)	
16.00	35.00	7.00	R-05	10533	(1)	
16.00	35.00	8.00	A-05	10536	(1)	
16.00	35.00	10.00	A-05	10532	(1)	
16.00	35.00	10.00	R-05	10535	(1)	
16.00	40.00	10.00	A-05	10538	(1)	
16.00	40.00	10.00	R-05	10537	(1)	
16.30	24.00	7.00	R-05	10541	(1)	00726BR
16.40	25.50	3.50	R-04	10544	(1)	
16.50	32.00	9.00	A-02	48890	(1)	
17.00	22.00	3.00	R-04	10374	(2)	
17.00	24.00	7.00	R-02	10550	(1)	
17.00	25.00	3.00	R-04	10554	(1)	02640GR
17.00	25.00	4.00	A-04	18838	(1)	02669GA
17.00	25.00	4.00	R-02	10552	(1)	02571BRG
17.00	25.00	4.00	R-05	10553	(1)	02161BR
17.00	26.00	6.00	R-05	10555	(1)	
17.00	26.00	8.00	R-05	10557	(1)	
17.00	28.00	5.00	A-05	10559	(1)	
17.00	28.00	5.00	R-02	10558	(1)	02701BRG
17.00	28.00	6.00	A-05	10561	(1)	01072BA
17.00	28.00	6.00	B-07	10564	(1)	
17.00	28.00	6.00	R-05	10563	(1)	01072BR
17.00	28.00	7.00	A-02	10565	(1)	00508BAG
17.00	28.00	7.00	A-05	10567	(1)	00508BA
17.00	28.00	7.00	R-02	10566	(1)	
17.00	28.00	7.00	R-05	10568	(1)	
17.00	28.00	7.00	R-05	38883	(2)	
17.00	28.00	8.00	B-07	18845	(1)	
17.00	28.00	8.00	R-02	18843	(1)	
17.00	28.00	8.00	R-07	18842	(1)	01784BRO
17.00	28.05	5.00	R-05	10562	(1)	02375BR
17.00	30.00	5.00	A-04	18846	(1)	
17.00	30.00	7.00	B-02	56789	(1)	
17.00	30.00	7.00	R-02	10572	(1)	02730BRG
17.00	30.00	7.00	R-05	10573	(1)	
17.00	30.00	7.00	R-07	48635	(2)	02963BROF
17.00	31.00	8.00	R-05	10578	(1)	
17.00	31.20	7.50	A-05	10576	(1)	01464BA
17.00	32.00	7.00	R-02	10581	(1)	01725BRG
17.00	32.00	7.00	R-05	50527	(1)	01725BR
17.00	32.00	10.00	R-05	10583	(1)	
17.00	32.90	3.60	A-02	10585	(1)	02944BAG
17.00	33.00	7.00	A-05	10586	(1)	
17.00	34.00	7.00	A-02	40257	(5)	01916BAGP
17.00	35.00	5.00	R-05	10591	(1)	
17.00	35.00	6.00	R-05	10590	(1)	
17.00	35.00	7.00	R-02	57417	(2)	
17.00	35.00	7.00	R-05	10592	(1)	00853BR
17.00	35.00	8.00	A-05	10595	(1)	

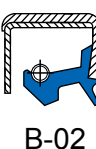

Eixo	Aloj.	Alt.	Modelo	Código CBV	T. M.	Conversão
17.00	35.00	8.00	R-02	47807	(1)	
17.00	35.00	8.00	R-05	10596	(1)	01511BR
17.00	35.00	8.00	R-05	38536	(8)	
17.00	35.00	10.00	A-05	10599	(1)	
17.00	35.00	10.00	R-02	10597	(1)	01415BRG
17.00	35.00	10.00	R-05	10600	(1)	00828BR
17.00	35.30	7.00	R-02	10593	(1)	01113BRG
17.00	37.00	7.00	R-02	50415	(1)	
17.00	37.00	7.00	R-05	10602	(1)	
17.00	39.90	5.00	A-02	10605	(1)	
17.00	40.00	6.00	R-05	46021	(2)	
17.00	40.00	7.00	R-05	54870	(1)	
17.00	40.00	8.00	R-02	53756	(1)	
17.00	40.00	8.50	R-02	54419	(2)	01492BRF
17.00	40.00	8.50	R-05	10607	(1)	01492BR
17.00	40.00	10.00	R-02	10612	(1)	
17.00	42.00	8.00	R-02	53578	(1)	
17.00	47.00	7.00	R-05	10614	(1)	
17.00	47.00	10.00	R-05	10615	(1)	
17.46	28.57	7.93	R-05	54289	(1)	
17.46	28.58	5.80	R-02	56793	(2)	
17.46	28.58	6.35	R-02	49705	(1)	
17.46	28.58	7.14	R-07	18852	(1)	
17.46	34.93	7.94	A-04	53674	(1)	
17.50	25.00	4.00	R-04	20227	(1)	02627GR
17.50	28.30	7.00	R-05	10629	(1)	01496BR
17.50	28.50	7.00	R-02	56791	(2)	
17.50	30.30	4.50	R-04	18853	(1)	01871GR
17.60	40.10	7.10	A-05	10631	(1)	
17.80	35.00	9.50	B-05	20226	(1)	00608B
18.00	24.00	3.00	A-04	18861	(1)	02510GA
18.00	24.00	4.00	R-04	10635	(1)	02567GR
18.00	25.00	6.00	A-02	10633	(1)	
18.00	26.00	4.00	A-04	18862	(1)	
18.00	26.00	7.00	A-05	10637	(1)	
18.00	28.00	7.00	A-05	10641	(1)	
18.00	28.00	7.00	B-05	10642	(1)	
18.00	28.00	7.00	R-02	53175	(1)	
18.00	28.00	7.00	R-05	10643	(2)	
18.00	28.50	4.00	A-05	10638	(1)	
18.00	30.00	6.00	R-02	54144	(1)	
18.00	30.00	7.00	A-05	10648	(1)	
18.00	30.00	7.00	R-02	10647	(1)	00496BRG
18.00	30.00	7.00	R-02	38884	(2)	
18.00	30.00	7.00	R-05	10649	(1)	
18.00	32.00	7.00	A-05	10652	(1)	
18.00	32.00	7.00	R-02	10653	(1)	
18.00	32.00	8.00	R-02	10654	(1)	
18.00	35.00	6.00	R-2S	10658	(1)	
18.00	35.00	7.00	A-02	10666	(1)	
18.00	35.00	7.00	A-05	10659	(1)	
18.00	35.00	7.00	R-05	10531	(1)	
18.00	35.00	10.00	R-02	10668	(1)	01769BRG
18.00	35.00	10.00	R-05	10665	(1)	01769BR
18.00	37.00	8.00	R-02	10671	(1)	02164BRG
18.00	40.00	9.00	R-02	10330	(1)	

T. M. = Tipo de Material

(1) 70 NBR (2) 70 FPM (3) 80 NBR (4) 80 FPM (5) 70 ACM (6) 70 CR (7) 63 PG (8) 70 VMQ (9) 70 EPDM (10) 90 PU

Eixo	Aloj.	Alt.	Modelo	Código CBV	T. M.	Conversão
18.00	40.00	9.00	R-05	10673	(1)	01107BR
18.00	40.00	9.00	R-05	54281	(2)	01107BRF
18.00	47.00	8.00	R-05	10677	(1)	01400BR
18.20	30.00	6.00	R-02	18868	(1)	
18.50	38.30	6.35	A-05	38892	(2)	
18.70	34.90	8.70	B-02	10683	(1)	00745BGO
18.80	31.70	11.10	A-02	10684	(1)	02203BAG
19.00	25.40	3.20	A-04	10685	(1)	00888GA
19.00	27.00	6.00	R-05	10686	(1)	
19.00	28.00	6.00	R-05	10687	(1)	
19.00	28.50	4.00	A-04	20228	(1)	01868GA
19.00	28.50	4.00	R-04	81759	(1)	
19.00	28.50	4.00	R-04	81897	(2)	
19.00	28.55	6.50	A-02	10718	(1)	02131BAG
19.00	28.65	4.70	A-05	10716	(1)	01455BA
19.00	29.10	6.40	R-05	10689	(1)	01909BR
19.00	30.00	7.00	A-02	57289	(1)	
19.00	30.00	7.00	R-02	10688	(1)	
19.00	30.00	7.00	R-02	48486	(2)	
19.00	30.00	7.60	R-05	10693	(1)	
19.00	30.10	7.50	A-05	10691	(1)	01527BA
19.00	31.60	7.70	R-05	10694	(1)	02263BR
19.00	31.70	6.40	B-02	10723	(1)	
19.00	31.70	6.40	B-05	10722	(1)	00569B
19.00	31.70	6.40	R-05	10724	(1)	00569BR
19.00	31.75	8.00	A-02	10727	(1)	00989BAG
19.00	31.75	8.00	A-05	10698	(1)	00989BA
19.00	31.80	6.40	R-05	10695	(1)	00821BR
19.00	31.85	9.50	B-02	10733	(1)	00338BGO
19.00	31.90	7.00	A-05	10696	(1)	00798BA
19.00	32.50	6.50	A-02	56242	(2)	
19.00	33.30	9.50	R-05	40259	(1)	
19.00	34.90	9.50	B-05	10701	(1)	00959B
19.00	34.95	10.30	A-05	40260	(5)	01965BAP
19.00	35.00	6.00	R-02	18871	(1)	
19.00	35.00	7.00	R-02	47248	(1)	00784BRG
19.00	35.00	7.00	R-05	10699	(1)	00784BR
19.00	35.00	9.00	R-02	10700	(1)	
19.00	35.00	10.00	R-05	10702	(1)	00159BR
19.00	36.10	8.50	R-05	10705	(1)	01407BR
19.00	38.00	7.00	R-05	38885	(2)	
19.00	38.05	10.00	B-05	10706	(1)	00158B
19.00	41.25	8.00	A-05	10757	(1)	00714BA
19.00	41.30	11.00	A-05	10759	(1)	01465BA
19.00	42.10	7.00	R-05	10711	(1)	01235BR
19.05	28.05	6.00	R-05	10623	(1)	
19.05	31.75	3.57	A-04	18877	(1)	
19.05	31.75	4.76	A-04	18879	(1)	
19.05	33.33	7.93	R-02	18886	(1)	
19.05	39.69	9.53	A-05	56788	(1)	
19.05	44.45	6.35	R-05	10763	(1)	
19.05	52.00	8.00	A-05	10679	(1)	
19.15	52.20	8.00	A-05	38886	(2)	
19.30	29.10	6.40	R-05	10713	(1)	01110BR
19.50	30.00	6.00	R-02	54625	(2)	
19.50	30.00	6.00	R-02	56176	(1)	

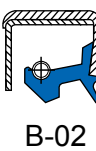

Eixo	Aloj.	Alt.	Modelo	Código CBV	T. M.	Conversão
19.50	38.50	10.00	R-05	55609	(1)	
19.84	44.45	8.33	R-05	10779	(1)	
19.90	35.00	7.00	R-02	10814	(1)	01894BRG
19.90	44.40	7.90	A-05	10865	(1)	01723BAE
20.00	26.00	4.00	A-04	18900	(1)	02573GA
20.00	26.00	4.00	R-04	18901	(1)	02573GR
20.00	28.00	4.00	A-04	18903	(1)	
20.00	28.00	4.00	R-04	18904	(1)	02641GR
20.00	28.00	4.00	R-04	47480	(2)	02641GRF
20.00	28.00	6.00	R-02	10783	(1)	
20.00	28.00	6.00	R-02	55896	(2)	
20.00	28.00	6.00	R-05	10782	(1)	
20.00	28.00	6.00	R-05	47668	(1)	
20.00	28.20	4.00	A-05	18906	(1)	
20.00	30.00	4.50	R-05	10784	(1)	
20.00	30.00	5.00	R-05	10785	(1)	
20.00	30.00	5.00	R-05	51790	(2)	
20.00	30.00	7.00	A-02	10787	(1)	01935BAG
20.00	30.00	7.00	A-07	11584	(1)	01566BAO
20.00	30.00	7.00	R-02	10788	(1)	
20.00	30.00	7.00	R-02	53608	(9)	
20.00	30.00	7.00	R-02	48251	(2)	
20.00	30.00	7.00	R-05	10791	(1)	00505BR
20.00	31.00	7.00	A-05	10793	(1)	02285BA
20.00	31.20	7.50	A-05	10795	(1)	01328BA
20.00	32.00	5.00	A-04	18908	(1)	
20.00	32.00	5.00	A-05	10794	(1)	00767BA
20.00	32.00	5.00	R-02	47417	(1)	
20.00	32.00	6.00	R-02	10803	(1)	
20.00	32.00	6.00	R-05	10798	(1)	00712BR
20.00	32.00	7.00	A-02	10800	(1)	
20.00	32.00	7.00	A-05	10804	(1)	
20.00	32.00	7.00	R-02	10802	(1)	
20.00	32.10	7.00	R-05	10801	(1)	00953BR
20.00	33.00	10.00	R-05	53831	(1)	
20.00	34.05	7.00	R-02	52117	(1)	01718BRG
20.00	34.05	7.00	R-05	10808	(1)	01718BR
20.00	34.95	4.50	A-04	18911	(1)	01777GA
20.00	34.95	6.00	A-05	10811	(1)	00715BA
20.00	34.95	7.00	R-02	47722	(1)	02486BRG
20.00	34.95	7.00	R-05	10816	(1)	02486BR
20.00	35.00	6.00	R-02	10812	(1)	02821BRG
20.00	35.00	7.00	A-05	47926	(1)	
20.00	35.00	7.00	R-02	10815	(1)	
20.00	35.00	7.00	R-05	38887	(2)	
20.00	35.00	8.00	R-02	10820	(1)	01386BRG
20.00	35.00	8.00	R-02	57287	(1)	
20.00	35.00	8.00	R-05	10819	(1)	01386BR
20.00	35.00	8.00	R-07	18912	(1)	
20.00	35.00	10.00	A-02	10822	(1)	
20.00	35.00	10.00	B-02	10824	(1)	
20.00	35.00	10.00	R-02	10821	(1)	
20.00	35.00	10.00	R-05	10823	(1)	00760BR
20.00	35.00	10.00	R-05	54525	(2)	00760BRF
20.00	35.10	4.00	R-05	10810	(1)	01404BR
20.00	35.10	5.80	R-04	18910	(1)	01866GR

T. M. = Tipo de Material

(1) 70 NBR (2) 70 FPM (3) 80 NBR (4) 80 FPM (5) 70 ACM (6) 70 CR (7) 63 PG (8) 70 VMQ (9) 70 EPDM (10) 90 PU

Eixo	Aloj.	Alt.	Modelo	Código CBV	T. M.	Conversão
20.00	36.00	8.00	R-02	54394	(2)	
20.00	36.00	10.00	R-05	10827	(1)	00918BR
20.00	37.00	6.00	A-05	10829	(1)	
20.00	37.00	6.00	R-05	10828	(1)	
20.00	37.00	7.00	R-02	10933	(1)	
20.00	38.00	6.00	R-02	10834	(1)	03004BRG
20.00	38.00	7.00	R-05	54152	(1)	
20.00	38.00	8.00	R-05	10837	(1)	
20.00	38.05	6.40	A-05	40261	(5)	02072BAP
20.00	38.10	10.00	R-05	10839	(1)	01189BR
20.00	39.00	5.00	R-05	10840	(1)	
20.00	39.70	6.50	R-02	10844	(1)	02433BRG
20.00	40.00	4.00	A-05	10841	(1)	01694BA
20.00	40.00	4.00	A-05	40263	(5)	01694BAP
20.00	40.00	7.00	A-02	10847	(1)	02468BRG
20.00	40.00	7.00	A-05	10845	(1)	00994BA
20.00	40.00	7.00	R-02	10842	(1)	00994BRG
20.00	40.00	7.00	R-02	39157	(2)	02566BRGPF
20.00	40.00	7.00	R-05	20230	(1)	01245BR
20.00	40.00	7.90	R-02	10848	(1)	
20.00	40.00	8.00	R-07	38889	(2)	
20.00	40.00	10.00	A-02	10853	(1)	00360BA
20.00	40.00	10.00	R-05	10851	(1)	
20.00	40.00	10.00	R-05	54518	(2)	00360BR
20.00	40.30	10.00	R-05	10852	(1)	00922BR
20.00	42.00	7.00	R-05	10859	(1)	
20.00	42.00	10.00	A-05	10861	(1)	
20.00	42.00	10.00	B-05	10862	(1)	01746B
20.00	42.00	10.00	R-05	56205	(2)	
20.00	46.40	6.00	R-02	10867	(1)	
20.00	46.40	10.00	R-02	56782	(1)	
20.00	47.00	7.00	R-02	10869	(1)	
20.00	47.00	7.00	R-05	10870	(1)	
20.00	47.10	10.00	R-05	10873	(1)	00909BR
20.00	52.00	7.00	R-05	11302	(1)	
20.00	52.00	10.00	R-05	10884	(1)	
20.00	52.00	10.00	R-05	38891	(2)	
20.00	52.00	10.00	R-05	57288	(1)	
20.50	41.20	5.00	A-02	10908	(1)	00963BAG
20.60	31.70	4.90	A-02	40265	(5)	05040BAG
20.60	31.70	8.50	R-02	10886	(1)	
20.60	38.11	7.00	A-02	40266	(5)	02480BAGPF
20.62	34.88	9.52	B-05	10888	(1)	
20.64	50.80	7.94	R-02	10920	(1)	
20.70	34.85	11.90	A-02	10904	(1)	01254BAG
20.80	40.00	8.00	R-02	56257	(1)	
21.00	30.00	5.00	R-02	10644	(1)	
21.00	30.00	6.50	A-05	10922	(1)	
21.00	30.00	7.00	R-05	10921	(1)	
21.00	31.95	7.00	R-05	10926	(1)	01985BR
21.00	32.00	7.00	A-02	10924	(1)	01883BAG
21.00	32.00	7.00	A-05	10925	(1)	
21.00	32.00	7.50	A-02	10927	(1)	02371BAG
21.00	32.00	9.00	A-02	10923	(1)	
21.00	35.00	6.00	A-05	10930	(1)	
21.00	35.00	7.00	R-05	53832	(1)	



A-02



A-04

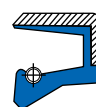

A-05

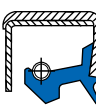

B-02

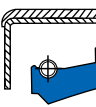

B-05



R-02



R-04



R-05



R-07

Eixo	Aloj.	Alt.	Modelo	Código CBV	T. M.	Conversão
21.00	35.00	8.00	R-05	10928	(1)	
21.50	40.00	7.00	R-05	10940	(5)	02418BRP
21.80	25.00	1.90	A-04	18936	(1)	02073GA
21.80	31.70	5.00	R-05	10938	(1)	
21.80	35.00	7.00	R-02	40269	(5)	02740BRGPF
21.80	36.50	6.40	A-05	38537	(8)	01967BAS
21.80	36.50	6.40	R-05	40267	(5)	
21.90	32.00	6.00	A-05	10944	(1)	02729BA
22.00	28.00	4.00	A-04	40339	(9)	
22.00	28.60	3.50	A-02	56220	(2)	
22.00	30.00	4.00	A-04	18938	(1)	
22.00	30.00	4.00	R-04	18939	(1)	
22.00	31.85	5.00	A-05	18941	(1)	00769BA
22.00	32.00	5.50	R-05	10945	(1)	01727BR
22.00	32.00	7.00	A-05	10948	(1)	
22.00	32.00	7.00	R-02	10947	(1)	01554BRG
22.00	32.00	7.00	R-05	10949	(1)	
22.00	32.00	8.00	A-02	56503	(2)	
22.00	33.00	8.00	R-05	10953	(1)	
22.00	35.00	6.00	R-02	10955	(1)	02579BRG
22.00	35.00	6.00	R-02	38893	(2)	
22.00	35.00	7.00	R-02	10958	(1)	02572BRG
22.00	35.00	7.00	R-05	40268	(5)	02533BRGPF
22.00	35.00	7.00	R-05	10960	(1)	01716BR
22.00	35.00	9.00	A-02	10963	(1)	00955BAG
22.00	35.00	9.00	R-02	10964	(1)	
22.00	35.00	10.00	A-02	10965	(1)	00118BAG
22.00	35.00	10.00	A-05	10968	(1)	00118BA
22.00	35.00	10.00	R-05	54185	(1)	
22.00	35.20	6.70	R-05	10959	(1)	00294BR
22.00	37.00	7.00	R-05	10972	(1)	
22.00	38.00	6.00	R-05	57327	(1)	
22.00	38.00	7.00	R-02	56223	(2)	
22.00	38.05	8.00	R-05	11032	(1)	01112BR
22.00	40.00	5.00	R-05	10977	(1)	
22.00	40.00	7.00	R-02	56149	(2)	
22.00	40.00	7.00	R-05	10978	(1)	00761BR
22.00	40.00	8.00	B-05	40270	(5)	02009BP
22.00	40.00	8.00	R-02	10980	(1)	00992BRG
22.00	40.00	8.00	R-05	10981	(1)	
22.00	40.00	10.00	B-05	10983	(1)	
22.00	40.00	10.00	R-02	10985	(1)	
22.00	41.00	6.00	R-02	10979	(1)	
22.00	41.25	8.00	A-05	11044	(1)	01481BA
22.00	42.00	7.00	R-02	10988	(1)	
22.00	42.00	10.00	A-05	10990	(1)	
22.00	42.00	10.00	R-05	38890	(2)	
22.00	42.00	10.00	R-05	40271	(5)	01914BRP
22.00	42.00	10.00	R-05	47430	(1)	00815BR
22.00	45.00	7.00	R-05	10995	(1)	
22.00	47.00	7.00	R-02	11000	(1)	
22.00	47.00	9.00	B-05	10874	(1)	01779B
22.00	50.00	10.00	R-05	11008	(1)	
22.10	35.00	8.00	A-04	18948	(1)	02126GA
22.20	31.00	6.00	A-02	47590	(1)	02878BAG
22.20	34.95	8.00	A-02	11021	(1)	00937BAG

T. M. = Tipo de Material

(1) 70 NBR (2) 70 FPM (3) 80 NBR (4) 80 FPM (5) 70 ACM (6) 70 CR (7) 63 PG (8) 70 VMQ (9) 70 EPDM (10) 90 PU

Eixo	Aloj.	Alt.	Modelo	Código CBV	T. M.	Conversão
22.20	34.95	8.00	B-05	11025	(1)	00937B
22.20	35.00	8.00	A-05	10962	(1)	01819BA
22.20	50.70	12.70	B-05	56779	(1)	
22.20	50.80	11.11	A-02	11062	(1)	02064BAG
22.23	28.58	3.20	A-04	10941	(1)	02715GA
22.23	31.70	6.00	A-05	11012	(1)	02357BA
22.23	33.15	10.30	A-05	11016	(1)	00150BA
22.23	34.85	8.00	B-02	11022	(1)	00937BGO
22.23	34.90	8.00	A-04	40341	(1)	02126GA
22.23	34.93	6.35	R-02	50789	(1)	
22.23	34.95	8.00	B-05	38895	(2)	
22.23	34.95	8.00	R-02	38894	(2)	
22.23	34.98	6.50	A-02	40272	(5)	05041BAG
22.23	38.10	7.94	B-02	11030	(1)	
22.23	38.10	8.00	A-05	11031	(1)	2240
22.23	38.10	8.33	R-02	11034	(1)	
22.23	38.10	9.50	B-05	11009	(1)	00100B
22.23	51.50	10.50	A-02	47324	(1)	
22.30	34.95	6.40	R-05	11020	(1)	00572BR
22.50	42.00	9.50	R-05	47319	(1)	
23.00	30.00	7.00	R-02	11941	(1)	
23.00	35.00	8.00	A-02	11071	(1)	02372BAG
23.00	35.00	8.00	A-02	38896	(2)	02837BAG
23.00	40.00	5.00	A-04	18973	(1)	
23.00	40.00	5.00	R-04	18974	(1)	
23.00	40.00	8.00	R-05	11075	(1)	
23.00	40.00	10.00	A-05	11078	(1)	
23.00	40.00	10.00	B-02	11076	(1)	
23.00	40.00	10.00	R-05	11080	(1)	
23.00	41.00	10.00	R-05	46538	(1)	
23.00	42.00	7.00	A-05	11082	(1)	
23.30	59.95	6.40	A-04	18975	(1)	01613GA
23.50	35.00	10.00	A-02	10966	(1)	
23.50	40.00	6.00	R-02	53819	(1)	
23.80	34.50	7.00	R-05	11088	(1)	02029BR
23.80	38.05	6.50	A-02	11091	(1)	02465BAG
23.80	38.05	7.90	B-05	11093	(1)	01836B
23.80	39.00	6.20	R-04	18981	(1)	01867GR
23.80	44.50	8.50	B-02	55917	(1)	
23.81	34.93	7.54	A-05	11089	(1)	
23.81	44.45	9.13	R-05	11097	(1)	
24.00	32.00	4.00	A-05	11105	(1)	
24.00	32.00	4.00	R-04	18990	(1)	
24.00	32.00	7.00	A-02	11106	(1)	
24.00	32.00	7.00	R-04	18988	(1)	
24.00	33.00	7.00	R-02	57329	(1)	
24.00	35.00	5.00	A-04	54098	(1)	
24.00	35.00	5.50	A-05	11109	(1)	
24.00	35.00	6.00	R-05	47586	(2)	02594BRF
24.00	35.00	7.00	R-05	11110	(1)	
24.00	36.00	6.00	R-05	11116	(1)	01666BR
24.00	36.00	7.00	R-02	11112	(1)	
24.00	36.00	7.00	R-05	11114	(1)	
24.00	36.00	9.00	A-05	11117	(1)	
24.00	37.00	7.00	A-05	11120	(1)	
24.00	37.00	7.00	R-02	11115	(1)	02210BRG

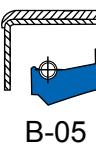
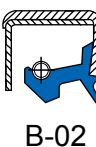

Eixo	Aloj.	Alt.	Modelo	Código CBV	T. M.	Conversão
24.00	38.00	8.00	R-02	11123	(1)	
24.00	38.00	9.00	R-05	11124	(1)	00829BR
24.00	40.00	7.00	A-05	11127	(1)	
24.00	40.00	7.00	R-05	11128	(1)	
24.00	40.00	10.00	B-05	11130	(1)	
24.00	40.10	10.00	R-05	11129	(1)	01341BR
24.00	42.00	10.00	R-05	11132	(1)	01507BR
24.00	43.00	10.00	A-05	53833	(1)	
24.00	47.00	7.00	R-05	11136	(1)	00763BR
24.00	47.00	10.00	R-05	11138	(1)	
24.00	50.00	10.00	R-05	11141	(1)	
24.00	52.00	7.00	R-05	38897	(2)	
24.00	52.00	10.00	R-05	38898	(2)	
24.00	52.00	12.00	B-05	11143	(1)	
24.40	38.30	7.90	A-02	19038	(1)	
24.60	39.80	8.00	R-05	50861	(1)	
24.60	39.90	8.00	A-02	11146	(1)	01712BAG
24.61	41.28	7.94	B-05	51809	(1)	
24.61	42.86	7.94	A-02	11148	(1)	
24.61	44.45	7.94	A-02	11152	(1)	
24.61	44.45	7.94	A-02	53765	(2)	
24.61	44.45	9.92	A-05	11154	(1)	
24.80	44.50	8.00	R-02	18998	(1)	
24.80	44.50	8.00	R-02	56256	(2)	
25.00	32.00	4.00	A-04	19000	(1)	02265GA
25.00	32.00	4.00	R-04	19001	(1)	02588GR
25.00	32.00	4.00	R-05	19002	(1)	
25.00	32.00	5.00	A-04	19006	(1)	
25.00	32.00	6.00	R-02	55600	(2)	
25.00	32.00	7.00	A-02	11158	(1)	
25.00	32.00	7.00	A-05	11156	(1)	
25.00	32.00	7.00	R-05	11157	(1)	
25.00	32.00	7.00	R-07	46587	(2)	
25.00	33.00	5.00	A-04	19004	(1)	
25.00	33.00	6.00	R-05	11160	(1)	
25.00	33.00	7.00	R-02	11163	(1)	
25.00	35.00	4.00	A-04	19005	(1)	
25.00	35.00	5.00	A-04	19007	(1)	02107GA
25.00	35.00	6.00	A-05	11113	(1)	
25.00	35.00	6.00	R-02	46023	(2)	
25.00	35.00	7.00	A-02	56737	(1)	
25.00	35.00	7.00	A-05	11167	(1)	01543BA
25.00	35.00	7.00	R-02	38899	(2)	02802BRGF
25.00	35.00	7.00	R-02	47674	(1)	02802BRG
25.00	35.00	7.00	R-05	11168	(1)	01543BR
25.00	35.00	7.00	R-07	56445	(1)	
25.00	35.00	7.50	A-02	40273	(5)	02007BAGP
25.00	35.00	7.50	R-05	38900	(2)	
25.00	35.00	8.00	R-02	20231	(1)	02414BRG
25.00	35.00	10.00	A-02	11170	(1)	00788BAG
25.00	36.00	6.00	A-02	11172	(1)	
25.00	36.00	7.00	A-05	55389	(1)	
25.00	36.00	7.00	R-02	11177	(1)	
25.00	36.00	7.00	R-05	11178	(1)	01515BR
25.00	36.50	4.00	R-04	57056	(1)	
25.00	37.00	5.00	R-02	11180	(1)	

T. M. = Tipo de Material

(1) 70 NBR (2) 70 FPM (3) 80 NBR (4) 80 FPM (5) 70 ACM (6) 70 CR (7) 63 PG (8) 70 VMQ (9) 70 EPDM (10) 90 PU

Eixo	Aloj.	Alt.	Modelo	Código CBV	T. M.	Conversão
25.00	37.00	7.00	A-05	11181	(1)	
25.00	37.00	7.00	R-02	11182	(1)	
25.00	37.00	7.30	R-02	11186	(1)	01577BRG
25.00	37.00	7.30	R-05	11184	(1)	01577BR
25.00	37.00	7.30	R-05	38901	(2)	01577BRF
25.00	37.00	9.00	R-02	20239	(1)	
25.00	37.90	7.00	R-02	11189	(1)	01892BRG
25.00	38.00	6.00	R-04	19014	(1)	
25.00	38.00	6.40	R-05	11190	(1)	01019BR
25.00	38.00	7.00	R-05	11122	(1)	01214BR
25.00	38.00	8.00	A-05	11192	(1)	
25.00	38.00	8.00	B-05	11193	(1)	01118B
25.00	38.00	8.33	B-02	11194	(1)	
25.00	38.00	10.00	R-02	11196	(1)	
25.00	40.00	5.00	R-04	18627	(1)	01295GR
25.00	40.00	7.00	A-05	11203	(1)	02062BA
25.00	40.00	7.00	R-02	11201	(1)	02570BRG
25.00	40.00	7.00	R-02	38902	(2)	02570BRGF
25.00	40.00	8.00	R-02	11208	(1)	02233BRG
25.00	40.00	8.00	R-02	40274	(5)	02712BRGP
25.00	40.00	8.00	R-05	11207	(1)	01556BR
25.00	40.00	8.00	R-05	50694	(2)	
25.00	40.00	8.00	R-07	50705	(2)	
25.00	40.00	9.00	R-02	11210	(1)	02148BRG
25.00	40.00	10.00	A-05	53834	(1)	
25.00	40.00	10.00	B-05	11212	(1)	00469B
25.00	40.00	10.00	R-05	54147	(2)	
25.00	41.10	9.50	R-05	11219	(1)	00191BR
25.00	41.28	9.53	R-02	42668	(1)	
25.00	41.55	10.80	R-02	11222	(1)	
25.00	42.00	6.00	R-02	11224	(1)	01604BRG
25.00	42.00	6.00	R-02	38903	(2)	01604BRGF
25.00	42.00	6.00	R-05	11223	(1)	01604BR
25.00	42.00	7.00	R-02	38904	(2)	
25.00	42.00	7.00	R-02	48684	(1)	
25.00	42.00	7.00	R-05	11225	(1)	
25.00	42.00	8.00	A-05	11227	(1)	00925BA
25.00	42.00	8.00	R-05	11228	(1)	
25.00	42.00	10.00	B-05	11233	(1)	
25.00	42.00	10.00	R-02	11230	(1)	
25.00	42.00	10.00	R-02	51946	(2)	
25.00	42.00	10.00	R-05	11397	(1)	
25.00	42.86	9.53	A-05	11235	(1)	
25.00	43.00	6.00	R-05	11236	(1)	
25.00	43.00	9.00	R-05	11239	(1)	
25.00	43.00	10.00	R-02	11238	(1)	
25.00	43.05	10.00	R-05	11241	(1)	00506BR
25.00	44.00	7.00	R-02	51087	(1)	
25.00	44.00	7.00	R-05	50211	(1)	
25.00	44.00	9.00	R-02	51780	(1)	
25.00	44.90	5.00	R-05	11244	(1)	00709BR
25.00	44.95	7.00	A-02	10333	(1)	
25.00	44.95	7.00	A-05	11245	(1)	01397BA
25.00	45.00	7.00	R-02	11246	(1)	
25.00	45.00	9.00	R-02	56152	(1)	
25.00	45.00	10.00	R-05	11249	(1)	

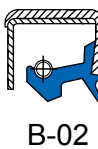

Eixo	Aloj.	Alt.	Modelo	Código CBV	T. M.	Conversão
25.00	46.00	7.50	R-05	11254	(1)	
25.00	47.00	6.00	A-02	11261	(1)	02010BAG
25.00	47.00	7.00	A-05	11258	(1)	02010BA
25.00	47.00	7.00	R-02	11259	(1)	02010BRG
25.00	47.00	7.00	R-05	11260	(1)	02010BR
25.00	47.00	7.00	R-07	19023	(1)	02010BRO
25.00	47.00	10.00	R-02	11264	(1)	02046BRG
25.00	47.00	10.00	R-05	11267	(1)	00266BR
25.00	47.00	10.00	R-05	38538	(8)	
25.00	48.00	7.50	R-05	11269	(1)	
25.00	50.00	10.00	R-02	56768	(1)	
25.00	50.10	10.00	R-05	11272	(1)	00499BR
25.00	50.20	10.00	R-02	56769	(2)	
25.00	51.00	10.00	R-02	11273	(1)	
25.00	52.00	7.00	A-02	11280	(1)	
25.00	52.00	7.00	A-05	11282	(1)	
25.00	52.00	7.00	R-05	11281	(1)	
25.00	52.00	8.00	R-02	11283	(1)	02727BRG
25.00	52.00	8.00	R-02	56291	(2)	
25.00	52.00	10.00	B-05	11287	(1)	
25.00	52.00	10.00	R-02	11289	(1)	00463BRG
25.00	52.00	10.00	R-05	11288	(1)	00463BR
25.00	52.00	10.00	R-05	38907	(2)	
25.00	52.00	12.00	R-05	11290	(1)	
25.00	54.00	8.00	R-05	11294	(1)	
25.00	55.00	9.00	A-05	11296	(1)	
25.00	55.00	9.00	R-05	11295	(1)	
25.00	60.00	8.00	R-05	11298	(1)	
25.00	62.00	10.00	B-05	11301	(1)	00770B
25.00	62.00	10.00	R-02	47418	(1)	
25.00	72.00	10.00	A-02	11305	(1)	
25.40	34.80	5.00	A-04	19030	(1)	01405GA
25.40	34.90	6.40	A-05	11311	(1)	00448BA
25.40	34.93	4.76	A-05	11310	(1)	
25.40	36.40	6.40	R-05	11173	(1)	00283BR
25.40	38.00	6.50	B-05	11326	(1)	02230B
25.40	38.00	9.50	A-02	11331	(1)	01327BAG
25.40	38.05	8.00	A-02	11327	(1)	
25.40	38.05	8.00	B-02	11329	(1)	02172BG
25.40	38.05	8.00	B-05	46952	(1)	00768B
25.40	38.05	10.00	A-02	47477	(1)	00141BAG
25.40	38.05	10.00	A-05	11333	(1)	00141BA
25.40	38.10	6.35	A-02	11323	(1)	01356BAG
25.40	38.10	6.35	A-05	11325	(1)	
25.40	38.10	6.35	R-05	11324	(1)	
25.40	38.10	9.53	R-05	11332	(1)	
25.40	38.10	9.53	R-05	40275	(1)	
25.40	40.08	6.35	R-02	51001	(1)	
25.40	41.25	9.50	B-05	11338	(1)	00934B
25.40	41.28	6.35	R-05	11342	(1)	
25.40	41.28	6.35	R-05	38909	(2)	
25.40	41.28	7.94	A-05	11343	(1)	
25.40	42.86	6.35	R-05	11346	(1)	
25.40	44.45	6.35	R-05	11355	(1)	
25.40	44.45	8.00	A-02	11356	(1)	
25.40	44.45	8.30	B-05	11357	(1)	00844B

T. M. = Tipo de Material

(1) 70 NBR (2) 70 FPM (3) 80 NBR (4) 80 FPM (5) 70 ACM (6) 70 CR (7) 63 PG (8) 70 VMQ (9) 70 EPDM (10) 90 PU

Eixo	Aloj.	Alt.	Modelo	Código CBV	T. M.	Conversão
25.40	44.50	6.50	A-02	40276	(5)	02527BAGP
25.40	44.60	5.30	R-04	19044	(1)	01156GR
25.40	44.60	6.40	R-05	11354	(1)	01009BR
25.40	46.04	4.76	B-05	47962	(2)	
25.40	46.43	11.11	B-02	11370	(1)	
25.40	46.45	9.50	B-05	11368	(1)	00145B
25.40	46.83	4.76	R-05	11372	(1)	
25.40	47.55	11.10	B-05	11376	(1)	01302B
25.40	47.63	6.35	R-05	11374	(1)	
25.40	50.70	10.20	A-05	11385	(1)	01393BA
25.40	50.75	15.80	B-02	11389	(1)	01547BGO
25.40	50.80	12.70	R-04	19055	(1)	
25.50	40.00	7.00	R-02	11395	(1)	
26.00	31.00	3.00	A-04	19063	(1)	01830GA
26.00	35.00	7.00	R-02	11401	(1)	02568BRG
26.00	37.00	7.00	R-02	11407	(1)	01045BRG
26.00	37.00	7.00	R-05	11410	(1)	
26.00	40.00	5.00	R-04	19064	(1)	01778GR
26.00	40.00	8.00	R-02	11412	(1)	02412BRG
26.00	42.00	7.00	R-05	11414	(1)	
26.00	42.00	8.00	R-02	38539	(8)	02177BRG
26.00	42.00	10.00	B-05	11419	(1)	
26.00	42.00	10.00	R-02	11417	(1)	01151BRG
26.00	43.00	10.00	A-05	11421	(1)	00785BA
26.00	45.00	10.00	A-05	11423	(1)	01860BA
26.00	47.00	7.00	R-05	11425	(1)	
26.00	47.00	7.00	R-05	38911	(2)	
26.00	47.00	9.00	B-05	11426	(1)	
26.00	47.00	10.00	A-05	11428	(1)	
26.00	47.00	10.00	R-05	11429	(1)	
26.00	50.00	10.00	R-05	11430	(1)	
26.30	33.30	3.20	A-04	19066	(1)	01683GA
26.80	29.95	1.90	A-04	19070	(1)	01785GA
26.90	42.98	8.74	A-05	11478	(1)	
26.98	42.82	7.90	A-02	19071	(1)	
26.98	42.86	7.14	R-05	19069	(1)	
26.99	47.63	9.53	R-05	11457	(1)	
27.00	33.35	3.00	A-04	11466	(1)	
27.00	33.52	3.30	R-04	47390	(1)	
27.00	33.80	4.00	R-04	47141	(1)	
27.00	33.95	3.00	A-05	20250	(1)	02691GA
27.00	36.20	7.40	R-05	54156	(1)	
27.00	37.00	5.50	R-02	50938	(1)	
27.00	37.00	7.00	R-05	11468	(1)	
27.00	38.00	6.30	R-02	12295	(1)	
27.00	38.10	6.40	A-05	11437	(1)	00285BA
27.00	38.10	6.40	R-05	11438	(1)	01993BR
27.00	39.00	6.00	R-02	55372	(2)	
27.00	39.00	6.00	R-02	56412	(1)	
27.00	40.00	7.00	R-02	11475	(1)	01751BRG
27.00	41.80	7.10	A-05	11445	(1)	00121BA
27.00	42.00	10.00	R-02	11477	(1)	01625BRG
27.00	43.00	9.00	B-05	11481	(1)	
27.00	43.00	11.00	B-02	51058	(2)	
27.00	47.00	7.00	R-02	56756	(1)	
27.00	47.00	7.00	R-05	11480	(1)	

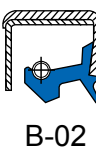

Eixo	Aloj.	Alt.	Modelo	Código CBV	T. M.	Conversão
27.00	47.00	8.00	R-02	11482	(1)	
27.00	47.00	10.00	A-05	11483	(1)	
27.00	47.00	10.00	R-05	11485	(1)	
27.00	47.60	7.00	A-02	38540	(8)	
27.00	51.00	6.50	R-05	55464	(1)	
27.00	52.00	13.00	R-02	54563	(1)	
27.00	72.00	9.50	R-02	46092	(1)	
27.50	62.00	10.00	R-02	38912	(2)	
28.00	34.90	5.00	A-04	19083	(1)	00713GA
28.00	35.00	4.00	R-04	19082	(1)	
28.00	35.00	6.00	A-04	19085	(1)	
28.00	38.00	6.50	R-02	11220	(1)	
28.00	38.00	6.50	R-04	19090	(1)	01886GR
28.00	38.00	6.50	R-05	19092	(1)	
28.00	38.00	10.00	R-05	11495	(1)	
28.00	39.95	8.00	R-07	19094	(1)	02157BRO
28.00	40.00	5.00	A-04	19095	(1)	02106GA
28.00	40.00	7.00	A-05	11502	(1)	
28.00	40.00	7.00	R-02	11499	(1)	02519BRG
28.00	40.00	7.00	R-02	11499	(1)	
28.00	40.00	7.00	R-05	11501	(1)	01495BR
28.00	40.00	7.00	R-05	38913	(2)	01495BRF
28.00	40.00	7.00	R-05	38541	(8)	01495BRS
28.00	40.00	8.00	A-05	11489	(1)	02413BA
28.00	40.00	8.00	R-02	47706	(1)	02413BRG
28.00	40.00	8.00	R-05	11503	(1)	
28.00	40.00	10.00	B-05	11504	(1)	
28.00	41.50	6.00	R-02	56218	(1)	
28.00	42.00	7.00	B-05	11509	(1)	01580B
28.00	42.00	7.00	R-02	11508	(1)	02145BRG
28.00	42.00	7.00	R-05	11511	(1)	
28.00	42.00	7.50	A-05	11512	(1)	
28.00	42.00	8.00	R-05	11514	(1)	
28.00	42.50	8.00	R-05	54155	(1)	
28.00	43.00	10.00	A-02	11520	(1)	
28.00	44.50	6.30	B-05	11521	(1)	
28.00	45.00	7.00	R-02	56216	(1)	
28.00	45.00	10.00	A-05	11525	(1)	
28.00	45.22	8.00	R-05	38914	(2)	
28.00	47.00	7.00	A-05	11527	(1)	
28.00	47.00	7.00	R-02	11528	(1)	
28.00	47.00	8.00	A-05	47322	(1)	
28.00	47.00	10.00	A-05	11531	(1)	00262BA
28.00	47.00	10.00	B-05	11533	(1)	00262B
28.00	47.00	10.00	R-05	11534	(1)	00262BA
28.00	47.50	9.50	R-02	56755	(1)	
28.00	47.50	9.50	R-05	11535	(1)	00947BR
28.00	48.00	8.00	R-02	51382	(1)	
28.00	48.00	10.00	R-02	56754	(2)	
28.00	50.00	12.00	B-05	11543	(1)	01020B
28.00	50.00	12.00	R-05	11544	(1)	
28.00	52.00	6.00	R-02	11545	(1)	
28.00	52.00	7.00	A-05	11546	(1)	
28.00	52.00	7.00	R-05	55844	(1)	
28.00	52.00	9.00	R-02	57424	(2)	
28.00	52.00	12.00	B-02	11552	(1)	

T. M. = Tipo de Material

(1) 70 NBR (2) 70 FPM (3) 80 NBR (4) 80 FPM (5) 70 ACM (6) 70 CR (7) 63 PG (8) 70 VMQ (9) 70 EPDM (10) 90 PU

Eixo	Aloj.	Alt.	Modelo	Código CBV	T. M.	Conversão
28.00	52.00	13.00	R-02	56283	(1)	
28.00	52.10	10.00	R-02	47717	(1)	
28.00	52.10	10.00	R-05	11550	(1)	00503BR
28.00	62.00	10.00	A-05	11556	(1)	
28.00	62.00	12.00	B-05	11555	(1)	
28.00	72.00	10.00	A-02	56752	(1)	
28.20	37.95	6.00	R-05	40277	(5)	02549BRP
28.20	43.00	9.10	B-05	11518	(1)	00607B
28.40	45.00	8.50	R-05	11563	(1)	01188BR
28.40	54.00	11.50	A-05	20241	(1)	
28.50	36.50	7.00	A-04	19108	(1)	00122GA
28.50	38.00	7.00	R-02	47471	(1)	
28.50	39.00	5.00	R-02	49661	(1)	
28.50	50.80	9.53	A-05	11620	(1)	00771BA
28.50	50.90	10.00	R-05	11619	(1)	
28.50	51.00	6.50	A-05	19105	(1)	
28.50	52.00	5.00	A-05	50608	(1)	
28.58	38.10	6.35	R-05	11567	(1)	
28.58	41.28	7.94	A-04	47279	(1)	
28.58	41.28	7.94	A-05	49608	(1)	
28.58	41.28	7.94	R-05	11576	(1)	
28.58	41.28	9.53	B-02	11578	(1)	
28.58	46.43	11.11	B-02	11603	(2)	
28.58	46.83	5.16	R-04	19120	(1)	
28.58	47.60	9.53	B-02	11609	(1)	
28.58	47.63	11.11	B-05	11612	(1)	
28.58	49.21	15.88	R-05	11615	(1)	
28.58	50.80	6.35	A-04	19126	(1)	
28.58	50.80	6.35	A-05	11618	(1)	
28.58	50.80	6.35	R-02	45723	(2)	
28.58	52.39	6.35	R-02	11625	(1)	
28.58	53.98	12.70	R-05	11632	(1)	
28.58	61.91	7.94	R-02	11638	(1)	
28.58	73.03	11.91	R-05	11644	(1)	
28.60	34.90	3.20	A-04	19104	(1)	01539GA
28.60	38.00	7.00	R-05	11497	(1)	01022BR
28.60	38.06	6.00	R-05	11565	(1)	01299BR
28.60	38.10	6.50	A-05	11566	(1)	01964BA
28.60	39.65	6.40	R-05	11569	(1)	00581BR
28.60	39.70	9.50	R-05	11572	(1)	00054BR
28.60	39.75	4.70	R-04	19110	(1)	00117GR
28.60	39.75	7.00	R-05	11570	(1)	00932BR
28.60	40.20	5.00	A-04	19114	(1)	02337GA
28.60	40.20	5.00	R-04	81752	(1)	
28.60	40.20	5.00	R-04	81747	(4)	
28.60	41.20	7.00	A-02	38915	(2)	02731BAGF
28.60	41.25	6.50	A-02	19101	(1)	02877BAG
28.60	41.25	6.50	A-05	11575	(1)	02355BA
28.60	41.30	9.40	A-02	47486	(1)	01962BAG
28.60	41.30	9.40	A-05	11580	(1)	01962BA
28.60	42.95	6.50	A-02	47583	(1)	01661BAG
28.60	44.50	11.00	A-02	47581	(1)	00634BAG
28.60	44.50	11.00	B-02	11595	(1)	00634B
28.60	46.55	11.30	B-05	11645	(1)	00056B
28.60	50.30	9.50	B-05	13889	(1)	00950B
28.60	52.30	9.50	B-05	11627	(1)	00961B

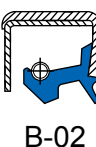

Eixo	Aloj.	Alt.	Modelo	Código CBV	T. M.	Conversão
28.60	57.15	9.50	R-05	11634	(1)	01635BR
28.70	31.80	3.00	A-04	19103	(1)	02361GA
28.70	40.00	7.00	A-05	40278	(5)	02140BAP
28.70	40.00	7.00	A-05	46022	(2)	
29.00	40.00	7.00	A-05	11647	(1)	
29.00	40.00	10.00	R-02	11648	(1)	
29.00	45.00	5.00	R-05	38920	(2)	
29.00	45.00	12.00	R-05	11653	(1)	
29.00	46.00	10.00	R-05	11654	(1)	
29.00	47.00	10.00	B-05	11656	(1)	
29.00	50.00	7.00	R-05	11657	(1)	
29.00	50.00	9.50	B-05	55483	(2)	
29.00	50.00	10.00	B-05	11655	(1)	02244B
29.00	50.00	10.50	R-05	11658	(1)	
29.00	50.50	9.50	B-05	55358	(2)	
29.00	54.00	10.00	R-02	11663	(1)	
29.00	55.00	10.00	R-02	11660	(1)	
29.00	62.00	10.00	R-02	53732	(1)	
29.00	62.00	10.00	R-02	51265	(2)	
29.00	64.00	10.00	R-02	11665	(1)	
29.37	39.29	6.35	R-04	19138	(1)	01121GR
29.40	42.83	8.00	R-02	50547	(1)	02153BRG
29.40	42.83	8.00	R-05	38916	(2)	02153BR
29.40	43.00	9.50	R-02	11651	(1)	
29.40	46.45	10.00	B-05	11664	(1)	00127B
29.50	43.00	10.00	R-02	11678	(1)	
29.90	45.00	7.00	A-05	11710	(1)	01833BA
29.90	58.10	8.00	A-05	11800	(1)	02407BA
30.00	36.00	5.00	R-04	53682	(2)	
30.00	36.95	3.00	A-04	11676	(1)	02788GA
30.00	37.00	4.00	A-04	19141	(1)	02643GA
30.00	37.00	4.00	R-04	14392	(1)	02643GR
30.00	37.00	7.00	R-04	11679	(1)	
30.00	37.10	4.00	A-05	11677	(1)	02096BA
30.00	38.00	4.00	R-05	11683	(1)	
30.00	38.00	6.00	R-05	38918	(2)	
30.00	38.00	7.00	R-02	55591	(1)	
30.00	38.00	8.00	R-05	11681	(1)	
30.00	39.00	8.00	R-05	11680	(1)	
30.00	40.00	4.00	R-05	11682	(1)	
30.00	40.00	4.00	R-05	38917	(2)	
30.00	40.00	5.00	R-04	53727	(1)	
30.00	40.00	7.00	A-05	56750	(1)	
30.00	40.00	7.00	R-02	11684	(1)	
30.00	40.00	7.00	R-05	11685	(1)	01535BR
30.00	40.00	7.00	R-05	40279	(5)	01903BRP
30.00	40.00	7.00	R-05	46024	(2)	
30.00	40.00	7.00	R-2R	50293	(1)	
30.00	40.00	8.00	A-05	11687	(1)	00810BA
30.00	40.00	8.00	R-05	11689	(1)	
30.00	40.00	10.00	A-02	11691	(1)	
30.00	42.00	6.00	R-02	11694	(1)	
30.00	42.00	7.00	A-02	11697	(1)	00847BAG
30.00	42.00	7.00	A-05	11699	(1)	
30.00	42.00	7.00	B-02	56841	(1)	
30.00	42.00	7.00	R-02	11696	(1)	

T. M. = Tipo de Material

(1) 70 NBR (2) 70 FPM (3) 80 NBR (4) 80 FPM (5) 70 ACM (6) 70 CR (7) 63 PG (8) 70 VMQ (9) 70 EPDM (10) 90 PU

Eixo	Aloj.	Alt.	Modelo	Código CBV	T. M.	Conversão
30.00	42.00	7.00	R-02	56747	(5)	
30.00	42.00	7.00	R-02	56746	(2)	
30.00	42.00	7.00	R-05	11700	(1)	00847BR
30.00	42.00	7.00	R-05	38919	(2)	00847BRF
30.00	42.00	10.00	R-02	11705	(1)	02234BRG
30.00	42.00	10.00	R-02	56229	(2)	
30.00	42.05	8.00	A-02	56748	(1)	
30.00	42.05	8.00	R-02	47584	(1)	
30.00	42.05	8.00	R-05	11703	(1)	01667BR
30.00	42.95	9.50	A-02	20233	(1)	00813BAG
30.00	42.95	9.50	A-05	20232	(1)	00813BA
30.00	43.00	7.00	A-05	11706	(1)	
30.00	44.00	7.00	R-02	47438	(5)	05530BRGP
30.00	44.00	8.00	R-05	54151	(1)	
30.00	44.00	8.50	A-04	54205	(1)	
30.00	44.50	10.00	B-05	11708	(1)	
30.00	44.60	9.50	R-05	11707	(1)	
30.00	45.00	7.00	R-05	11711	(1)	
30.00	45.00	8.00	A-05	11712	(1)	
30.00	45.00	8.00	R-05	11713	(1)	
30.00	45.00	10.00	R-05	11714	(1)	
30.00	45.00	12.00	R-05	11715	(1)	00832BR
30.00	45.00	13.00	R-02	11716	(1)	
30.00	46.40	10.00	A-05	11732	(1)	01831BA
30.00	47.00	6.00	R-02	11722	(1)	
30.00	47.00	6.00	R-02	57161	(2)	
30.00	47.00	6.00	R-05	11718	(1)	01695BR
30.00	47.00	7.00	B-05	56249	(1)	
30.00	47.00	7.00	R-02	11721	(1)	02376BRG
30.00	47.00	7.00	R-02	38543	(8)	02678BRGS
30.00	47.00	7.00	R-05	11720	(1)	
30.00	47.00	7.00	R-05	38921	(2)	
30.00	47.00	7.00	R-05	38544	(8)	02977BRS
30.00	47.00	8.00	A-02	38923	(2)	
30.00	47.00	8.00	A-05	11723	(1)	
30.00	47.00	8.00	R-02	38922	(2)	
30.00	47.00	8.00	R-02	38546	(8)	
30.00	47.00	8.00	R-02	53678	(1)	00455BRG
30.00	47.00	8.00	R-05	11724	(1)	
30.00	47.00	8.00	R-05	38924	(2)	
30.00	47.00	9.00	B-05	11728	(1)	
30.00	47.00	10.00	A-05	11731	(1)	
30.00	47.00	10.00	B-05	11733	(1)	
30.00	47.00	10.00	R-02	11729	(1)	
30.00	47.00	10.00	R-02	40281	(5)	02930BRGP
30.00	47.00	10.00	R-02	56743	(2)	
30.00	47.00	10.00	R-05	11734	(1)	00131BR
30.00	47.00	10.00	R-07	19146	(1)	
30.00	47.00	10.70	R-05	38925	(2)	
30.00	48.00	8.00	R-05	54154	(1)	
30.00	48.00	10.00	R-05	11740	(1)	
30.00	48.00	12.00	R-05	54677	(1)	
30.00	50.00	5.00	A-04	19147	(1)	
30.00	50.00	7.00	A-05	11744	(1)	
30.00	50.00	7.00	R-05	54158	(1)	
30.00	50.00	8.00	R-02	50697	(1)	

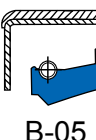
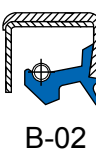

Eixo	Aloj.	Alt.	Modelo	Código CBV	T. M.	Conversão
30.00	50.00	10.00	R-02	11748	(1)	
30.00	50.00	10.00	R-05	11750	(1)	00358BR
30.00	50.00	10.00	R-05	38926	(2)	
30.00	50.00	11.00	R-02	11752	(1)	00911BRG
30.00	50.00	12.00	A-02	11754	(1)	
30.00	50.00	12.00	B-05	11756	(1)	
30.00	50.00	12.00	R-05	11753	(1)	
30.00	50.05	12.00	A-05	11755	(1)	00484BA
30.00	50.75	11.00	B-05	50373	(1)	00701B
30.00	50.80	11.10	R-05	55965	(1)	
30.00	51.00	7.00	R-02	56290	(2)	
30.00	52.00	7.00	A-02	11763	(1)	02006BAG
30.00	52.00	7.00	A-05	11765	(1)	
30.00	52.00	7.00	R-05	11766	(1)	
30.00	52.00	8.00	R-02	20234	(1)	02813BRG
30.00	52.00	8.00	R-05	11769	(1)	00952BR
30.00	52.00	8.00	R-05	57402	(2)	
30.00	52.00	9.00	B-05	11770	(1)	02401B
30.00	52.00	9.00	B-05	38547	(8)	01743BS
30.00	52.00	10.00	B-05	11774	(1)	
30.00	52.00	10.00	R-02	11776	(1)	
30.00	52.00	10.00	R-05	11775	(1)	00949BR
30.00	52.00	12.00	A-05	11781	(1)	01952BA
30.00	52.00	12.00	B-05	11757	(1)	00824B
30.00	52.00	12.00	R-02	55545	(1)	
30.00	52.35	6.00	R-02	11761	(1)	
30.00	55.00	7.00	R-05	11785	(1)	
30.00	55.00	10.00	A-05	11787	(1)	
30.00	55.00	10.00	R-02	38928	(2)	
30.00	55.00	10.00	R-02	53644	(1)	
30.00	55.00	12.00	A-02	11790	(1)	
30.00	55.00	12.00	A-05	11791	(1)	00772BA
30.00	56.00	10.00	A-05	11794	(1)	
30.00	56.00	10.00	R-05	11796	(1)	
30.00	56.00	12.00	A-05	11797	(1)	
30.00	56.00	12.00	R-05	11798	(1)	00817BR
30.00	58.10	11.00	A-05	19140	(1)	07299BA
30.00	60.00	10.00	R-05	11801	(1)	
30.00	62.00	7.00	R-02	56741	(1)	
30.00	62.00	7.00	R-05	11805	(1)	
30.00	62.00	7.00	R-05	38929	(2)	
30.00	62.00	10.00	R-02	11810	(1)	
30.00	62.00	10.00	R-02	38930	(2)	
30.00	62.00	10.00	R-05	11813	(1)	
30.00	62.00	10.10	A-05	11811	(1)	01273BA
30.00	62.00	14.00	R-05	38931	(2)	
30.00	63.00	7.00	R-02	11809	(1)	
30.00	72.00	9.50	R-05	11822	(1)	01182BR
30.00	72.00	10.00	B-02	11819	(1)	01581BGO
30.00	72.00	10.00	R-02	11820	(1)	
30.00	72.00	10.00	R-02	56235	(2)	
30.00	75.00	7.00	R-02	56200	(1)	
30.00	75.00	8.00	R-02	56740	(1)	
30.00	75.00	10.00	R-02	54324	(1)	
30.16	50.40	12.70	B-05	11840	(1)	
30.16	50.80	11.11	A-02	11843	(1)	

T. M. = Tipo de Material

(1) 70 NBR (2) 70 FPM (3) 80 NBR (4) 80 FPM (5) 70 ACM (6) 70 CR (7) 63 PG (8) 70 VMQ (9) 70 EPDM (10) 90 PU

Eixo	Aloj.	Alt.	Modelo	Código CBV	T. M.	Conversão
30.16	52.40	10.32	A-05	53786	(2)	
30.20	47.00	8.00	A-02	47697	(1)	00455BAG
30.20	47.00	8.00	A-05	11833	(1)	00455BA
30.20	62.00	12.00	A-05	11814	(1)	01063BA
30.30	39.65	6.40	R-05	11866	(1)	01992BR
30.96	50.40	11.11	R-05	54157	(1)	
31.00	38.00	4.00	R-05	11405	(1)	
31.00	41.00	9.50	A-05	11873	(1)	00519BA
31.00	41.25	5.00	R-04	81885	(4)	
31.00	47.00	7.00	R-05	11876	(1)	00762BR
31.00	50.00	8.00	R-02	38932	(2)	02317BRAGF
31.00	52.00	8.00	R-05	54607	(1)	
31.50	45.00	8.00	R-02	56623	(1)	
31.70	42.80	7.90	A-02	11883	(1)	01630BAG
31.70	42.80	9.50	A-02	53835	(1)	
31.70	42.85	5.00	R-04	19178	(1)	00114GR
31.70	44.45	7.00	A-05	11894	(1)	01843BA
31.70	44.50	6.50	A-05	11892	(1)	01149BA
31.70	44.50	6.50	R-05	11893	(1)	01149BR
31.70	44.50	8.00	R-05	11898	(1)	00343BR
31.70	44.50	9.50	B-05	11901	(1)	01154B
31.70	50.30	11.10	B-05	11915	(1)	01698B
31.70	50.70	9.50	B-05	11920	(1)	00774B
31.70	50.70	11.00	B-05	11923	(1)	00028B
31.70	50.70	12.70	R-2S	11926	(1)	
31.70	50.80	11.10	A-02	11922	(1)	02063BAG
31.70	50.80	11.10	A-05	11921	(1)	
31.70	51.00	5.00	R-04	19193	(1)	01703GR
31.70	52.30	9.50	B-05	11935	(1)	01377B
31.70	53.95	6.50	A-02	40282	(5)	02052BAGP
31.70	54.10	6.50	R-02	56727	(2)	
31.75	38.10	3.95	R-04	19187	(1)	
31.75	38.10	6.35	R-04	19185	(1)	
31.75	44.45	6.35	A-04	55956	(1)	
31.75	44.45	7.94	R-07	55855	(1)	
31.75	44.45	9.30	B-05	38934	(2)	
31.75	44.45	11.11	R-05	11902	(1)	
31.75	46.43	5.55	A-05	38935	(2)	
31.75	50.40	11.11	A-02	11914	(1)	
31.75	50.80	5.50	R-05	50698	(1)	
31.75	50.80	6.00	R-02	11917	(1)	
31.75	50.80	7.94	A-02	54184	(1)	
31.75	50.80	7.94	R-05	11919	(1)	
31.75	50.80	11.11	R-05	54159	(1)	
31.75	50.80	12.70	R-02	11928	(1)	
31.75	51.20	9.00	A-05	38542	(8)	
31.75	53.98	6.35	A-02	56307	(8)	
31.75	53.98	9.53	B-05	53836	(1)	
31.75	53.98	11.11	R-05	11944	(1)	
31.75	53.98	11.11	R-05	42405	(6)	
31.75	57.15	6.35	R-02	34716	(1)	
31.75	60.33	12.70	R-02	11952	(1)	
31.80	42.80	9.50	B-05	11885	(1)	00017B
31.80	44.45	8.00	B-02	11896	(1)	02215BG
31.90	44.00	9.00	A-05	11975	(1)	01370BA
32.00	40.00	7.00	A-05	11966	(1)	

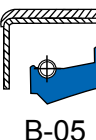
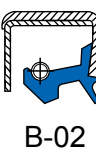

Eixo	Aloj.	Alt.	Modelo	Código CBV	T. M.	Conversão
32.00	40.00	7.00	R-02	11965	(1)	
32.00	42.00	4.00	A-04	11692	(1)	
32.00	42.00	7.00	A-02	11968	(1)	01310BAG
32.00	42.00	7.00	A-05	11969	(1)	
32.00	42.00	10.00	A-02	11970	(1)	
32.00	43.00	5.00	R-02	56224	(2)	
32.00	43.00	5.00	R-04	19219	(1)	02144GR
32.00	43.00	5.50	R-05	11972	(1)	
32.00	43.00	7.00	R-05	11973	(1)	01715BR
32.00	44.00	8.00	R-05	54153	(1)	
32.00	44.25	9.00	A-05	50355	(1)	00170BA
32.00	44.25	9.00	R-02	20235	(1)	00170BRG
32.00	45.00	6.00	R-05	11976	(1)	01726BR
32.00	45.00	6.50	R-04	11977	(1)	02987GR
32.00	45.00	7.00	A-02	19220	(1)	
32.00	45.00	7.00	A-05	11978	(1)	00495BA
32.00	45.00	7.00	R-02	11980	(1)	02397BRG
32.00	45.00	7.00	R-02	56287	(2)	
32.00	45.00	7.00	R-05	11979	(1)	
32.00	45.00	10.00	A-02	11982	(1)	
32.00	45.50	4.00	A-04	52089	(1)	
32.00	46.00	8.00	A-05	11984	(1)	
32.00	47.00	6.00	R-02	50688	(1)	
32.00	47.00	7.00	R-05	11985	(1)	
32.00	47.00	8.00	R-05	54160	(1)	
32.00	47.00	10.00	R-02	40283	(5)	01942BRGP
32.00	47.00	10.00	R-02	38937	(4)	02142BRGF
32.00	47.00	10.00	R-02	55603	(8)	
32.00	47.50	6.40	A-05	11986	(1)	01563BA
32.00	48.00	8.00	R-02	12265	(5)	05529BRGP
32.00	50.00	7.00	R-02	11996	(1)	
32.00	50.00	8.00	A-05	53731	(1)	
32.00	50.00	8.00	R-02	11998	(1)	00839BR
32.00	50.00	8.00	R-02	38938	(2)	
32.00	50.00	10.00	R-02	12001	(1)	
32.00	50.00	10.00	R-05	11999	(1)	
32.00	50.00	10.00	R-05	57313	(2)	
32.00	50.00	12.00	B-05	53837	(1)	
32.00	51.90	12.00	R-02	12014	(1)	01353BRG
32.00	52.00	6.50	R-02	12006	(1)	02699BRG
32.00	52.00	7.00	A-05	12005	(1)	
32.00	52.00	7.00	R-02	55557	(2)	
32.00	52.00	9.00	B-05	12007	(1)	01744B
32.00	52.00	9.00	R-05	12008	(1)	
32.00	52.00	10.00	R-02	56622	(1)	00801BR
32.00	52.00	11.00	R-02	56621	(1)	
32.00	52.10	10.00	R-05	12010	(1)	00801BR
32.00	54.10	6.50	R-02	56289	(1)	
32.00	55.00	10.00	A-05	53838	(1)	
32.00	55.00	10.00	R-02	46336	(2)	
32.00	56.00	10.00	R-05	12024	(1)	
32.00	57.05	9.50	A-05	12026	(1)	00477BA
32.00	62.00	7.00	R-05	12028	(1)	
32.00	65.00	8.00	R-02	56285	(1)	
32.00	65.00	13.00	A-02	12032	(1)	
32.00	65.00	13.00	A-02	50573	(5)	02184BAGP

T. M. = Tipo de Material

(1) 70 NBR (2) 70 FPM (3) 80 NBR (4) 80 FPM (5) 70 ACM (6) 70 CR (7) 63 PG (8) 70 VMQ (9) 70 EPDM (10) 90 PU

Eixo	Aloj.	Alt.	Modelo	Código CBV	T. M.	Conversão
32.00	72.00	10.00	B-05	12035	(1)	02270B
32.60	57.20	9.00	R-02	49235	(1)	
33.00	45.00	7.00	A-05	54101	(1)	
33.00	45.00	7.00	R-05	38940	(2)	02012BRF
33.00	45.00	7.00	R-05	54800	(1)	02012BR
33.00	48.00	6.50	R-05	20220	(1)	
33.00	50.00	6.00	R-02	12044	(1)	01603BRG
33.00	50.00	8.00	A-05	12047	(1)	01839BA
33.00	50.00	8.00	R-05	12049	(1)	01839BR
33.00	51.90	12.00	A-02	12054	(1)	01849BAG
33.00	52.00	6.00	R-05	12056	(1)	01589BR
33.00	52.00	10.00	R-05	12058	(1)	
33.00	52.00	12.00	A-02	12062	(1)	
33.00	57.00	9.00	A-05	12067	(1)	
33.00	60.00	10.00	R-02	12069	(1)	
33.00	62.00	12.00	R-02	38941	(2)	
33.20	57.20	12.80	R-02	12098	(1)	
33.30	46.40	9.50	A-05	50359	(1)	00322BA
33.30	46.40	9.50	R-05	12073	(1)	00322BR
33.30	53.95	11.00	B-02	12095	(1)	02242BG
33.30	69.40	7.90	A-05	12107	(1)	01040BA
33.33	42.86	6.35	R-02	56053	(1)	
33.34	47.63	7.94	A-05	49390	(1)	
33.45	50.90	13.00	A-02	12087	(1)	00816BAG
33.50	62.00	13.00	A-05	38942	(2)	
34.00	46.00	8.00	R-05	38943	(2)	
34.00	47.00	9.00	A-05	12117	(1)	
34.00	48.00	6.00	R-02	53934	(2)	
34.00	50.00	10.00	B-05	12122	(1)	
34.00	50.00	10.00	R-02	50534	(1)	
34.00	50.00	12.00	B-05	53839	(1)	
34.00	52.00	7.50	B-02	56323	(1)	
34.00	52.00	7.50	R-05	12125	(1)	01509BR
34.00	52.00	7.50	R-05	12125	(1)	01509BR
34.00	62.00	7.50	R-02	56248	(1)	
34.00	62.00	12.00	R-02	52098	(1)	
34.00	62.10	10.00	R-02	12133	(1)	01157BR
34.00	62.30	10.00	R-02	56494	(1)	
34.00	62.30	10.00	R-05	57162	(1)	
34.00	63.00	12.00	R-02	12134	(1)	03251BRG
34.00	63.50	8.00	R-05	12136	(1)	
34.00	64.00	8.00	R-02	56274	(1)	
34.13	53.58	11.91	R-05	12143	(1)	
34.50	48.05	8.80	R-05	12119	(1)	01048BR
34.50	48.05	8.80	R-05	12119	(1)	01048BR
34.50	55.50	12.00	A-02	38550	(8)	
34.90	47.55	8.00	A-02	40284	(5)	05043BAG
34.90	50.80	7.80	A-02	12171	(1)	
34.90	50.85	8.30	A-05	12175	(1)	02102BA
34.90	52.30	9.50	B-02	13100	(1)	
34.90	52.30	9.50	B-05	12187	(1)	01395B
34.90	53.50	6.50	A-04	19258	(1)	02315GA
34.90	55.90	12.50	A-02	12210	(1)	01844BAG
34.90	63.00	13.00	A-02	12371	(1)	01343BAG
34.92	53.97	9.52	R-02	12192	(1)	
34.93	47.63	6.35	A-05	12156	(1)	

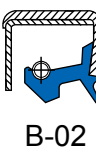

Eixo	Aloj.	Alt.	Modelo	Código CBV	T. M.	Conversão
34.93	47.63	6.35	A-05	38371	(6)	
34.93	47.63	11.11	B-05	12162	(1)	
34.93	48.00	6.35	A-05	47295	(1)	
34.93	49.21	6.35	R-05	12165	(1)	
34.93	50.80	7.94	R-05	40285	(1)	
34.93	50.80	8.33	B-05	12173	(1)	
34.93	50.80	8.33	R-05	12174	(1)	
34.93	50.80	9.53	A-05	12177	(1)	
34.93	50.80	11.11	A-02	38551	(8)	
34.93	53.98	11.11	B-05	12198	(1)	
34.93	55.85	9.30	R-02	54446	(2)	
34.93	57.15	7.94	A-05	12207	(1)	
34.93	57.15	7.94	R-02	12206	(1)	
34.93	57.94	9.53	R-05	12405	(1)	
34.93	61.91	11.91	R-02	12229	(1)	
34.93	63.50	9.53	R-05	12234	(1)	
34.93	72.23	11.91	R-05	12249	(1)	
35.00	42.00	4.00	A-04	19284	(1)	02095GA
35.00	42.00	4.00	R-04	19286	(1)	02632GR
35.00	42.00	7.00	R-04	19285	(1)	
35.00	44.50	7.00	A-05	12148	(1)	01502BA
35.00	44.65	10.00	R-02	56717	(1)	
35.00	45.00	4.00	R-04	19287	(1)	
35.00	45.00	6.00	R-05	50699	(1)	
35.00	45.00	7.00	A-05	12257	(1)	00822BA
35.00	45.00	7.00	R-05	12258	(1)	
35.00	45.00	7.00	R-05	12259	(1)	
35.00	45.00	10.00	A-05	53840	(1)	
35.00	45.00	10.00	R-05	12260	(1)	
35.00	46.45	6.40	R-02	12150	(1)	01526BRG
35.00	46.50	4.80	R-04	19288	(1)	01152GR
35.00	47.00	4.50	R-05	54676	(1)	
35.00	47.00	7.00	A-02	54627	(1)	00485BAG
35.00	47.00	7.00	A-05	12266	(1)	00485BA
35.00	47.00	7.00	R-02	12268	(1)	
35.00	47.00	7.00	R-02	38946	(2)	02962BRGF
35.00	47.00	7.00	R-05	12269	(1)	
35.00	47.00	7.00	R-05	38945	(2)	
35.00	47.00	9.00	A-05	56713	(2)	
35.00	47.00	9.00	B-05	12273	(1)	
35.00	47.00	9.00	R-02	56250	(2)	
35.00	47.00	10.00	A-05	56716	(1)	
35.00	47.05	9.00	R-05	12270	(1)	00969BR
35.00	47.05	10.00	R-05	12274	(1)	00520BR
35.00	47.15	7.00	R-05	12271	(1)	
35.00	47.55	9.50	B-05	12159	(1)	01041B
35.00	47.65	5.00	R-05	12154	(1)	
35.00	48.00	7.00	A-02	47571	(8)	02178BAGS
35.00	48.00	7.00	R-02	38552	(8)	02178BRGS
35.00	48.00	7.00	R-02	57163	(1)	
35.00	48.00	10.50	R-02	12278	(1)	02353BRGE
35.00	50.00	7.00	R-02	45722	(2)	05253BRGF
35.00	50.00	7.00	R-05	55390	(1)	
35.00	50.00	8.00	R-02	38553	(8)	02456BRGS
35.00	50.00	8.00	R-02	47481	(1)	00962BRG
35.00	50.00	8.00	R-05	12282	(1)	00962BR

T. M. = Tipo de Material

(1) 70 NBR (2) 70 FPM (3) 80 NBR (4) 80 FPM (5) 70 ACM (6) 70 CR (7) 63 PG (8) 70 VMQ (9) 70 EPDM (10) 90 PU

Eixo	Aloj.	Alt.	Modelo	Código CBV	T. M.	Conversão
35.00	50.00	10.00	A-05	12287	(1)	00789BA
35.00	50.00	10.00	B-02	12285	(1)	
35.00	50.00	10.00	B-05	12288	(1)	00789B
35.00	50.00	10.00	R-02	47231	(1)	
35.00	50.00	10.00	R-02	54668	(2)	
35.00	50.00	10.00	R-04	19292	(1)	
35.00	50.00	10.00	R-05	12289	(1)	00789BR
35.00	50.00	10.00	R-05	38947	(2)	
35.00	50.72	8.00	A-02	12294	(1)	
35.00	50.80	8.30	A-02	56316	(2)	
35.00	50.90	8.30	R-05	12178	(1)	
35.00	51.00	8.50	B-05	12176	(1)	
35.00	52.00	4.00	A-04	55478	(8)	
35.00	52.00	5.00	R-05	12296	(1)	
35.00	52.00	6.00	R-02	50312	(2)	
35.00	52.00	6.00	R-05	50810	(1)	
35.00	52.00	7.00	A-05	12297	(1)	
35.00	52.00	7.00	B-05	12298	(1)	
35.00	52.00	7.00	R-02	38949	(2)	
35.00	52.00	7.00	R-02	54298	(1)	
35.00	52.00	7.00	R-05	12300	(1)	
35.00	52.00	8.00	R-02	55847	(1)	
35.00	52.00	9.00	B-02	12301	(1)	
35.00	52.00	9.00	B-05	12302	(1)	
35.00	52.00	10.00	B-05	12307	(1)	
35.00	52.00	12.00	R-02	12309	(1)	00912BRG
35.00	52.00	12.00	R-02	38951	(2)	
35.00	52.00	12.00	R-05	12314	(1)	00758BR
35.00	52.10	7.00	R-05	38554	8	
35.00	52.10	10.00	R-02	12305	(1)	01742BRG
35.00	52.10	10.00	R-02	54410	(2)	
35.00	52.10	10.00	R-05	12308	(1)	01742BR
35.00	52.10	10.00	R-05	38950	(2)	
35.00	52.30	6.40	R-05	12189	(1)	
35.00	52.30	9.50	R-02	52118	(1)	00879BRG
35.00	52.30	9.50	R-05	12188	(1)	00879BR
35.00	53.90	9.50	B-05	12196	(1)	00694B
35.00	53.95	11.00	R-05	12313	(1)	00214BR
35.00	54.00	7.00	R-02	56225	(2)	
35.00	54.00	8.00	A-02	56712	(1)	
35.00	54.85	11.00	A-02	12322	(1)	01371BAG
35.00	55.00	5.00	A-04	54099	(1)	
35.00	55.00	8.00	R-02	12315	(1)	
35.00	55.00	8.00	R-05	12316	(1)	01980BR
35.00	55.00	8.00	R-05	38952	(2)	
35.00	55.00	10.00	A-05	12319	(1)	
35.00	55.00	10.00	R-02	12318	(1)	
35.00	55.00	10.00	R-05	12321	(1)	
35.00	55.00	11.00	R-05	12323	(1)	
35.00	55.50	6.40	R-05	12201	(1)	00284BR
35.00	56.00	8.00	R-05	54009	(1)	
35.00	56.00	10.00	A-02	12335	(1)	02087BAG
35.00	56.00	10.00	A-05	12333	(1)	
35.00	56.00	10.00	B-05	53841	(1)	
35.00	56.00	10.00	R-02	12330	(1)	
35.00	56.00	10.00	R-05	12332	(1)	02224BR

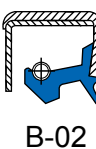

Eixo	Aloj.	Alt.	Modelo	Código CBV	T. M.	Conversão
35.00	56.00	12.00	B-05	54115	(1)	
35.00	56.05	12.00	A-05	12336	(1)	00492BA
35.00	57.90	6.40	A-04	19266	(1)	00258GA
35.00	58.00	10.00	R-05	12342	(1)	01551BR
35.00	60.00	10.00	R-05	55391	(1)	
35.00	60.00	10.00	R-05	55022	(2)	
35.00	60.25	12.70	R-05	12224	(1)	00009BR
35.00	60.30	9.50	A-02	47731	(1)	02304BAG
35.00	60.30	9.50	R-02	12221	(1)	02304BRG
35.00	61.80	7.50	A-04	19271	(1)	00026GA
35.00	62.00	5.00	R-04	53879	(1)	
35.00	62.00	7.00	B-05	56232	(1)	
35.00	62.00	7.00	R-02	12357	(1)	02091BAG
35.00	62.00	7.00	R-02	38954	(2)	
35.00	62.00	7.00	R-05	12356	(1)	
35.00	62.00	7.50	R-05	12359	(1)	
35.00	62.00	8.00	R-02	54678	(2)	
35.00	62.00	10.00	A-05	12361	(1)	00800BA
35.00	62.00	10.00	B-05	12362	(1)	
35.00	62.00	10.00	R-05	12363	(1)	01949BR
35.00	62.00	10.00	R-05	38955	(2)	
35.00	62.00	12.00	A-02	12364	(1)	02091BAG
35.00	62.00	12.00	A-05	12368	(1)	00136BA
35.00	62.00	12.00	B-05	12367	(1)	
35.00	62.00	12.00	R-02	12366	(1)	
35.00	62.00	12.00	R-05	12365	(1)	
35.00	63.00	10.00	B-05	12369	(1)	
35.00	63.00	10.00	R-05	12370	(1)	
35.00	63.10	14.00	R-02	12372	(1)	02303BRG
35.00	63.50	12.70	A-02	47410	(1)	00033BAG
35.00	63.50	12.70	B-05	12235	(1)	00033B
35.00	65.00	10.00	B-05	12377	(1)	
35.00	65.00	10.00	R-05	12376	(1)	
35.00	65.00	12.00	A-05	53842	(1)	
35.00	68.00	10.00	R-05	12381	(1)	
35.00	69.00	13.00	R-05	12382	(1)	
35.00	70.00	12.00	B-05	52093	(1)	
35.00	72.00	8.00	R-02	12386	(1)	
35.00	72.00	10.00	B-05	12387	(1)	01366B
35.00	72.00	10.00	B-05	38956	(2)	
35.00	72.00	10.00	R-05	38957	(2)	
35.00	72.00	12.00	A-05	12389	(1)	
35.00	72.00	12.00	R-02	12393	(1)	
35.00	80.00	6.00	A-05	12397	(1)	02151BA
35.00	80.00	10.00	R-02	12398	(1)	
35.00	80.00	10.00	R-02	38958	(2)	
35.00	80.00	12.00	R-05	12401	(1)	01954BR
35.00	80.00	13.00	B-05	12403	(1)	
35.00	82.90	10.00	R-02	12402	(1)	02732BRG
35.00	83.00	12.00	R-02	12404	(1)	
36.00	44.00	7.00	A-02	12409	(1)	
36.00	46.00	4.00	R-05	12407	(1)	
36.00	47.00	7.00	A-05	12411	(1)	
36.00	47.00	7.00	R-02	52032	(1)	
36.00	47.00	7.00	R-05	12412	(1)	
36.00	50.00	7.00	A-05	12413	(1)	

T. M. = Tipo de Material

(1) 70 NBR (2) 70 FPM (3) 80 NBR (4) 80 FPM (5) 70 ACM (6) 70 CR (7) 63 PG (8) 70 VMQ (9) 70 EPDM (10) 90 PU

Eixo	Aloj.	Alt.	Modelo	Código CBV	T. M.	Conversão
36.00	50.00	7.00	R-05	55567	(2)	
36.00	52.00	7.00	R-05	12419	(1)	
36.00	52.00	9.00	B-05	53846	(1)	
36.00	54.00	7.00	A-02	55902	(1)	
36.00	54.00	7.00	A-05	12423	(1)	02099BA
36.00	54.00	7.00	A-05	38555	(8)	
36.00	54.00	7.00	R-05	12424	(1)	00797BR
36.00	54.00	7.50	R-05	12426	(1)	01421BR
36.00	56.00	10.00	R-05	12428	(1)	00615BR
36.00	60.00	9.50	R-02	12433	(1)	01814BRG
36.00	62.00	7.00	R-05	12435	(1)	
36.00	63.00	10.00	R-02	12440	(1)	
36.10	56.00	10.00	R-05	46591	(1)	
36.50	57.05	12.70	B-05	12461	(1)	00218B
36.50	57.20	9.45	R-02	12458	(1)	
36.51	46.03	7.94	R-05	53573	(1)	
36.51	49.21	6.35	R-05	12445	(1)	
36.51	58.74	9.53	A-02	12464	(1)	
36.51	60.33	12.70	B-05	12465	(1)	
36.60	41.75	3.00	A-04	12476	(1)	01882GA
37.00	42.00	7.00	A-04	51038	(1)	
37.00	47.00	4.00	R-05	12477	(1)	
37.00	47.00	7.00	R-02	12478	(1)	
37.00	47.00	7.00	R-02	55751	(2)	
37.00	47.00	8.00	R-05	54623	(1)	
37.00	47.00	10.20	R-02	12155	(2)	05363BRGF
37.00	50.00	10.00	R-05	12480	(1)	01608BR
37.00	52.00	8.00	R-05	12482	(1)	
37.00	52.00	12.00	R-05	12485	(1)	
37.00	56.00	12.70	R-05	12483	(1)	
37.00	61.00	13.00	R-05	12490	(1)	00920BR
37.00	62.00	10.00	A-05	12494	(1)	
37.00	62.00	10.00	R-05	12493	(1)	
37.40	50.00	6.00	R-02	46332	(1)	
37.90	50.85	7.90	R-05	19335	(1)	01138BR
37.94	47.70	4.75	A-05	12507	(1)	
38.00	43.00	3.00	A-04	12505	(1)	02444GA
38.00	48.00	10.00	R-02	46353	(1)	
38.00	50.00	7.00	A-05	12510	(1)	00486BA
38.00	50.00	7.00	R-02	47712	(1)	
38.00	50.00	10.00	R-02	54631	(2)	
38.00	50.00	10.00	R-05	12513	(1)	
38.00	52.00	7.00	A-05	12541	(1)	
38.00	52.00	7.00	R-02	12517	(1)	00479BRG
38.00	52.00	7.00	R-02	56711	(2)	
38.00	52.00	7.00	R-05	38557	(8)	
38.00	52.00	8.00	R-02	38962	(2)	
38.00	52.00	10.00	A-05	12519	(1)	
38.00	52.00	10.00	R-02	12521	(1)	00479BRG
38.00	52.00	10.00	R-02	38964	(2)	
38.00	52.00	10.00	R-05	12520	(1)	00479BR
38.00	52.25	6.20	A-04	19343	(1)	01432GA
38.00	52.25	7.00	R-05	12516	(1)	02506BR
38.00	53.05	8.50	R-02	12523	(1)	01786BRG
38.00	54.00	6.50	R-05	55620	(2)	
38.00	54.00	10.00	A-05	12524	(1)	

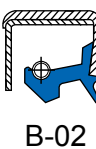

Eixo	Aloj.	Alt.	Modelo	Código CBV	T. M.	Conversão
38.00	54.00	10.00	R-05	12525	(1)	02051BR
38.00	55.00	7.00	R-02	12527	(1)	
38.00	55.00	8.00	A-02	12528	(1)	
38.00	55.00	8.00	R-02	57018	(2)	
38.00	55.00	10.00	B-05	12530	(1)	
38.00	55.00	11.00	R-05	54097	(1)	
38.00	55.00	12.00	B-05	53847	(1)	
38.00	56.00	8.00	B-05	12534	(1)	
38.00	56.00	10.00	R-05	12537	(1)	
38.00	56.00	12.00	A-05	12539	(1)	
38.00	57.00	7.00	A-02	12540	(1)	01657BAG
38.00	57.00	7.00	A-05	50524	(1)	01657BA
38.00	57.20	7.00	A-05	38963	(2)	
38.00	58.00	11.00	R-02	13458	(1)	
38.00	58.50	7.00	R-05	12547	(1)	01832BR
38.00	59.00	12.00	R-02	55665	(1)	
38.00	60.00	10.00	R-02	38965	(2)	
38.00	61.00	10.00	R-05	12556	(1)	
38.00	62.00	7.00	A-05	12554	(1)	02128BA
38.00	62.00	7.00	R-02	57414	(8)	
38.00	62.00	10.00	B-05	12558	(1)	
38.00	62.00	10.00	R-02	55547	(2)	
38.00	62.00	10.00	R-05	12557	(1)	
38.00	62.00	12.00	A-02	12560	(1)	
38.00	63.50	8.00	A-02	56292	(2)	
38.00	64.00	8.00	R-02	56201	(1)	
38.00	65.00	10.00	R-05	12562	(1)	
38.00	69.95	12.70	B-05	12643	(1)	01318B
38.00	73.95	11.00	A-02	12569	(1)	01710BAG
38.00	74.00	11.00	A-02	12568	(1)	02289BAG
38.00	80.00	12.00	R-05	12572	(1)	
38.00	90.00	8.00	R-05	47069	(1)	
38.10	47.60	6.40	A-05	12575	(1)	01536BA
38.10	47.60	7.00	A-05	12576	(1)	02385BA
38.10	50.10	7.00	R-05	12511	(1)	01355BR
38.10	50.30	11.10	B-05	12588	(1)	01284B
38.10	50.35	10.90	A-02	12579	(1)	01803BAG
38.10	50.75	5.50	A-04	19336	(1)	00470GA
38.10	50.75	5.50	A-05	12582	(1)	00470BA
38.10	50.75	9.50	A-05	12587	(1)	01659BA
38.10	50.75	9.50	R-02	56052	(1)	
38.10	50.80	6.35	A-04	19338	(1)	
38.10	50.80	7.93	B-05	19340	(1)	
38.10	52.30	6.35	B-05	12589	(1)	
38.10	54.10	11.00	R-05	12597	(1)	00203BR
38.10	55.55	6.40	A-05	12526	(1)	01396BA
38.10	57.10	11.00	A-07	12486	(1)	00254BAO
38.10	57.15	7.94	R-02	12602	(1)	
38.10	57.15	8.00	A-05	38966	(2)	02559BAF
38.10	57.15	9.53	R-05	12604	(1)	
38.10	58.75	10.50	A-04	19378	(1)	
38.10	60.30	12.70	A-02	12613	(1)	00049BAG
38.10	60.30	12.70	B-05	12619	(1)	00049B
38.10	60.33	7.94	A-05	54102	(1)	
38.10	60.33	9.53	A-02	49602	(1)	

T. M. = Tipo de Material

(1) 70 NBR (2) 70 FPM (3) 80 NBR (4) 80 FPM (5) 70 ACM (6) 70 CR (7) 63 PG (8) 70 VMQ (9) 70 EPDM (10) 90 PU

Eixo	Aloj.	Alt.	Modelo	Código CBV	T. M.	Conversão
38.10	60.33	9.53	R-05	38967	(2)	
38.10	60.33	12.70	B-05	12615	(1)	
38.10	60.35	12.70	R-02	12614	(1)	01854BRG
38.10	63.10	8.00	R-02	56326	(1)	
38.10	63.50	7.90	R-02	56284	(2)	
38.10	63.50	9.53	R-05	12624	(1)	
38.10	63.50	12.70	R-05	12631	(1)	00019BR
38.10	63.55	12.70	A-05	11506	(1)	
38.10	63.55	12.70	R-02	12629	(1)	02034BRG
38.20	63.50	11.10	A-05	12628	(1)	00995BA
38.89	60.33	12.70	R-02	12655	(1)	
39.00	52.00	6.50	A-05	56709	(1)	
39.00	55.50	9.00	A-05	12661	(1)	
39.00	60.00	9.00	A-02	12551	(1)	
39.00	70.00	12.20	R-02	56327	(1)	
39.10	62.20	6.40	A-04	19372	(1)	00373GA
39.37	57.33	6.35	R-04	81758	(1)	
39.40	60.30	12.70	R-07	19373	(1)	01997BRO
39.40	62.00	14.00	A-02	19374	(1)	00066BAG
39.40	63.55	12.70	R-02	12684	(1)	02038BRG
39.40	80.20	11.80	A-02	19376	(1)	01660BAGE
39.69	63.50	12.70	R-05	12686	(1)	
39.69	69.85	6.99	R-02	12698	(1)	
39.69	69.85	9.53	R-02	56710	(1)	
39.70	57.10	6.40	A-04	19381	(1)	01869GA
39.70	57.10	6.40	R-04	81890	(3)	
39.70	61.20	12.70	B-05	12673	(1)	00016B
39.70	62.00	11.00	R-02	45687	(8)	
39.70	63.45	12.70	B-05	12704	(1)	01811B
39.70	68.15	11.10	B-02	12694	(1)	00871BGO
40.00	47.00	5.00	A-04	56174	(1)	
40.00	50.00	4.00	A-04	19404	(1)	01419GA
40.00	50.00	4.00	R-04	19403	(1)	02633GR
40.00	50.00	5.00	R-02	12705	(1)	
40.00	50.00	5.00	R-02	38968	(2)	
40.00	50.00	6.00	A-05	12707	(1)	
40.00	50.00	7.00	R-02	12710	(1)	
40.00	50.00	8.00	R-02	54433	(2)	
40.00	50.00	10.00	R-05	12712	(1)	
40.00	52.00	4.80	R-04	12713	(1)	
40.00	52.00	5.50	R-02	12716	(1)	
40.00	52.00	6.00	R-02	12717	(1)	02822BRG
40.00	52.00	6.00	R-05	12714	(1)	
40.00	52.00	7.00	A-02	12718	(1)	
40.00	52.00	7.00	R-02	12715	(2)	
40.00	52.00	7.00	R-02	51880	(1)	
40.00	52.00	7.00	R-05	12720	(1)	
40.00	52.00	7.00	R-05	38970	(2)	
40.00	52.00	7.40	R-02	12721	(1)	01988BRG
40.00	52.00	8.00	R-02	38969	(2)	02430BRGF
40.00	52.00	8.00	R-05	12724	(1)	
40.00	52.00	8.00	R-05	38971	(2)	
40.00	52.00	9.00	A-02	12727	(1)	
40.00	52.00	9.00	R-02	40287	(1)	02068BRG
40.00	55.00	7.00	A-05	12735	(1)	
40.00	55.00	7.00	R-02	55601	(2)	

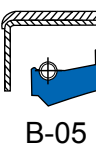
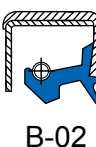

Eixo	Aloj.	Alt.	Modelo	Código CBV	T. M.	Conversão
40.00	55.00	7.00	R-05	12664	(1)	
40.00	55.00	8.00	A-02	48809	(1)	02972BAG
40.00	55.00	8.00	R-02	12733	(1)	01707BRG
40.00	55.00	8.00	R-02	38973	(2)	
40.00	55.00	8.00	R-02	40288	(5)	02541BRGP
40.00	55.00	9.00	A-05	12737	(1)	
40.00	55.00	9.00	B-05	12738	(1)	01155B
40.00	55.00	9.00	R-05	51347	(2)	
40.00	55.00	9.00	R-05	12739	(1)	
40.00	55.00	9.50	A-02	12740	(1)	02419BAG
40.00	55.00	10.00	B-05	12744	(1)	
40.00	55.00	10.00	R-02	12742	(1)	02739BRG
40.00	55.00	10.00	R-02	38974	(2)	02739BRGF
40.00	55.00	11.00	R-02	53735	(2)	
40.00	55.00	12.00	B-05	12818	(1)	
40.00	55.15	10.00	R-02	12743	(1)	01745BRG
40.00	56.00	4.50	R-02	55644	(2)	
40.00	56.00	6.00	R-02	55643	(2)	
40.00	56.00	6.00	R-05	12748	(1)	02031BR
40.00	56.00	7.00	A-02	12750	(5)	02005BAGP
40.00	56.00	7.00	A-02	38975	(2)	02302BAGF
40.00	56.00	7.00	A-02	50240	(1)	
40.00	56.00	7.00	R-05	57328	(1)	
40.00	56.00	8.00	R-02	47450	(1)	
40.00	56.00	8.00	R-05	12751	(1)	00880BR
40.00	56.00	8.50	R-04	19409	(1)	01759GR
40.00	56.00	9.00	A-02	12752	(1)	01265BAG
40.00	56.00	9.00	R-02	38976	(2)	
40.00	56.00	10.00	A-02	12755	(1)	01046BAG
40.00	56.00	10.00	A-05	12759	(1)	
40.00	56.00	10.00	R-05	54162	(1)	
40.00	56.10	12.00	R-05	12761	(1)	00265BR
40.00	57.00	7.00	A-02	56314	(1)	
40.00	57.00	12.00	R-05	12765	(1)	00924BR
40.00	58.00	7.00	R-02	50815	(1)	
40.00	58.00	8.00	A-05	12768	(1)	
40.00	58.00	8.00	R-02	56707	(1)	
40.00	58.00	8.00	R-05	38977	(2)	
40.00	58.00	9.00	R-02	12770	(1)	
40.00	58.00	9.00	R-02	12668	(2)	
40.00	58.00	9.70	R-02	56706	(1)	
40.00	58.00	10.00	B-05	12776	(1)	
40.00	58.00	10.00	R-02	12775	(1)	
40.00	58.00	12.00	R-05	12777	(1)	
40.00	58.10	8.00	A-02	56708	(2)	
40.00	60.00	8.00	R-05	12779	(1)	
40.00	60.00	8.00	R-05	49336	(2)	
40.00	60.00	10.00	B-05	12783	(1)	
40.00	60.00	10.00	R-02	47520	(1)	
40.00	60.00	10.00	R-05	12784	(1)	01116BR
40.00	60.00	12.00	R-02	55175	(1)	
40.00	60.00	12.00	R-05	12788	(1)	00897BR
40.00	60.00	12.00	R-05	53726	(2)	
40.00	62.00	7.00	R-02	12790	(1)	
40.00	62.00	7.00	R-02	38978	(2)	
40.00	62.00	8.00	R-02	12793	(1)	

T. M. = Tipo de Material

(1) 70 NBR (2) 70 FPM (3) 80 NBR (4) 80 FPM (5) 70 ACM (6) 70 CR (7) 63 PG (8) 70 VMQ (9) 70 EPDM (10) 90 PU

Eixo	Aloj.	Alt.	Modelo	Código CBV	T. M.	Conversão
40.00	62.00	8.00	R-02	55537	(2)	
40.00	62.00	10.00	B-05	12796	(1)	
40.00	62.00	10.00	R-02	12799	(1)	
40.00	62.00	10.00	R-02	38373	(6)	
40.00	62.00	10.00	R-02	56226	(2)	
40.00	62.00	11.50	R-02	12800	(1)	01109BRG
40.00	62.00	11.50	R-02	38979	(2)	01109BRGF
40.00	62.00	11.50	R-05	12801	(1)	01109BR
40.00	62.00	12.00	B-02	12676	(1)	02377BG
40.00	62.00	12.00	R-02	38980	(2)	
40.00	62.00	12.00	R-05	12803	(1)	00166BR
40.00	62.10	10.00	R-02	12797	(1)	01322BR
40.00	62.30	10.00	A-02	56705	(1)	
40.00	63.65	9.50	A-05	56574	(1)	
40.00	64.00	12.00	R-05	12806	(1)	
40.00	65.00	10.00	A-05	53849	(1)	
40.00	65.00	10.00	R-02	12807	(1)	
40.00	65.00	10.00	R-05	12809	(1)	
40.00	65.00	12.00	A-02	12811	(1)	01266BAG
40.00	65.00	12.00	B-02	12813	(1)	02088BGO
40.00	65.00	12.00	R-02	12812	(1)	
40.00	65.00	12.00	R-05	12814	(1)	
40.00	68.00	7.00	A-05	12820	(1)	
40.00	68.00	12.00	B-05	12822	(1)	
40.00	68.00	12.00	R-05	12823	(1)	02225BR
40.00	70.00	10.00	R-05	12825	(1)	
40.00	70.00	10.00	R-05	38981	(2)	
40.00	70.00	12.00	B-05	12826	(1)	00837B
40.00	70.00	12.00	R-02	56322	(1)	
40.00	70.00	12.50	R-02	56258	(1)	
40.00	72.00	7.00	A-02	12829	(1)	
40.00	72.00	7.00	R-05	12831	(1)	
40.00	72.00	7.00	R-05	54630	(2)	
40.00	72.00	10.00	A-05	12834	(1)	
40.00	72.00	10.00	R-02	54670	(2)	
40.00	72.00	11.50	R-02	12838	(1)	
40.00	72.00	12.00	A-02	12837	(1)	01602BAG
40.00	75.00	8.00	R-05	50692	(1)	
40.00	75.00	12.00	R-05	12842	(1)	
40.00	80.00	10.00	B-05	54114	(1)	
40.00	80.00	10.00	R-02	57185	(2)	
40.00	80.00	13.00	A-05	12848	(1)	
40.00	80.00	13.00	R-05	55868	(1)	
40.00	80.00	13.00	R-05	57342	(2)	
40.00	80.10	10.00	R-02	53609	(1)	
40.00	80.10	10.00	R-05	12843	(1)	00913BR
40.00	82.90	10.00	R-02	12849	(1)	02675BRG
40.00	90.00	12.00	B-05	12855	(1)	
40.20	52.00	7.00	A-05	12719	(1)	01491BA
40.50	53.00	7.00	B-02	38372	(6)	
40.50	53.95	7.20	A-02	38560	(8)	01958BAGS
40.60	75.40	12.40	B-05	12844	(1)	
40.80	44.05	3.10	A-04	19417	(1)	02322GA
41.00	60.00	8.00	R-05	50701	(1)	
41.00	62.00	10.00	A-05	56702	(1)	
41.00	62.00	10.00	B-05	12859	(1)	

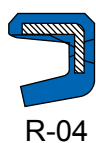
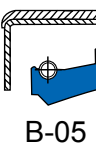
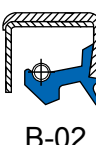

Eixo	Aloj.	Alt.	Modelo	Código CBV	T. M.	Conversão
41.00	62.00	10.00	R-05	57176	(1)	
41.00	80.00	7.00	R-05	12866	(1)	
41.10	49.30	6.50	A-02	12861	(1)	01963BAG
41.10	62.00	16.00	B-02	12893	(1)	00626BGO
41.10	65.40	13.00	A-02	12862	(1)	01100BAG
41.20	63.50	8.00	A-02	40292	(5)	02084BAGP
41.20	63.50	8.00	A-05	40291	(5)	02084BAP
41.28	50.80	4.76	A-04	19419	(1)	
41.28	60.30	6.35	A-05	12874	(1)	
41.28	60.33	9.50	R-2S	12880	(1)	
41.28	60.33	9.53	A-05	12879	(1)	
41.28	61.28	11.11	R-02	12887	(1)	
41.28	61.91	12.70	R-02	55403	(1)	
41.30	54.00	6.50	A-02	19421	(1)	02879BAG
41.30	54.00	6.50	A-05	12864	(1)	02356BA
41.30	57.20	9.50	R-02	56704	(1)	
41.30	59.10	8.00	A-02	12871	(1)	01989BAG
41.30	61.80	12.70	B-05	12892	(1)	01378B
41.30	62.00	12.70	B-02	56703	(1)	
41.30	63.55	6.50	A-02	40290	(5)	02053BAGP
41.30	63.55	12.70	R-05	12901	(1)	00133BR
41.30	66.55	12.70	B-05	12907	(1)	00692B
41.30	75.75	6.40	A-04	19446	(1)	00951GA
41.40	70.60	7.90	A-02	12923	(1)	01931BAG
42.00	50.00	10.00	A-05	12927	(1)	
42.00	50.00	10.00	R-02	12926	(1)	
42.00	52.00	4.00	A-04	19449	(2)	
42.00	52.00	7.00	A-05	54292	(1)	
42.00	52.00	7.00	R-02	54188	(2)	
42.00	53.00	7.00	R-02	38558	(2)	05250BRGF
42.00	55.00	8.00	R-05	12933	(1)	
42.00	55.00	9.00	A-02	38983	(2)	02058BAGF
42.00	55.00	10.00	R-07	46841	(6)	
42.00	56.00	7.00	A-02	12935	(1)	02321BAG
42.00	56.00	7.00	B-02	56565	(1)	
42.00	56.00	7.00	R-02	56222	(2)	
42.00	56.00	7.00	R-05	12934	(1)	00288BR
42.00	56.00	10.00	A-05	53852	(1)	
42.00	56.00	12.00	A-05	12941	(1)	
42.00	58.00	7.00	A-05	12943	(1)	02059BA
42.00	58.00	10.00	R-05	53853	(1)	
42.00	60.00	9.00	R-02	12947	(1)	02296BRG
42.00	60.00	10.00	A-05	12950	(1)	
42.00	60.00	10.00	R-05	12949	(1)	
42.00	62.00	6.00	R-05	12954	(1)	01802BR
42.00	62.00	7.00	A-02	12955	(1)	
42.00	62.00	7.00	R-05	12956	(2)	
42.00	62.00	7.50	B-05	12959	(1)	
42.00	62.00	8.00	R-05	12962	(1)	
42.00	62.00	8.00	R-05	38984	(2)	
42.00	62.00	10.00	B-05	12965	(1)	
42.00	62.00	12.00	A-05	12972	(1)	00361BA
42.00	62.00	12.00	R-05	12970	(1)	00361BR
42.00	62.10	10.00	R-05	12963	(1)	00521BR
42.00	64.90	12.00	A-02	12979	(1)	00561BAG
42.00	65.00	12.00	B-05	38985	(2)	01506BF

T. M. = Tipo de Material

(1) 70 NBR (2) 70 FPM (3) 80 NBR (4) 80 FPM (5) 70 ACM (6) 70 CR (7) 63 PG (8) 70 VMQ (9) 70 EPDM (10) 90 PU

Eixo	Aloj.	Alt.	Modelo	Código CBV	T. M.	Conversão
42.00	65.00	13.00	B-05	38562	(8)	01809BS
42.00	65.05	10.00	R-05	12977	(1)	01505BR
42.00	67.00	10.00	R-02	12983	(1)	
42.00	68.00	10.00	R-05	12984	(1)	
42.00	72.00	8.00	R-05	12987	(1)	
42.00	72.00	10.00	R-02	12989	(1)	
42.00	72.00	10.00	R-05	50532	(1)	02039BR
42.00	72.00	12.00	R-05	12992	(1)	01081BR
42.00	80.00	12.00	A-05	52064	(1)	
42.00	80.00	12.00	R-05	12996	(1)	
42.80	63.35	9.50	R-05	13013	(1)	00564BR
42.80	68.15	10.70	A-02	13022	(1)	
42.80	68.15	10.70	A-05	47664	(1)	00533BA
42.86	66.68	9.53	R-05	13019	(1)	
42.90	73.00	15.90	R-07	19466	(1)	01996BRO
43.00	52.00	6.50	A-04	19470	(1)	02981GA
43.00	52.00	8.00	R-02	54364	(1)	
43.00	60.00	7.00	R-05	13038	(1)	
43.00	60.00	10.00	R-05	13039	(1)	
43.00	62.00	7.00	B-02	56282	(1)	
43.00	62.00	8.00	A-05	13042	(1)	
43.00	62.00	8.00	R-05	13043	(1)	
43.00	62.00	10.00	B-05	13046	(1)	
43.00	62.00	10.00	R-05	13044	(1)	00604BR
43.00	63.80	9.50	R-05	13045	(1)	
43.00	70.00	8.00	R-02	57354	(2)	
43.00	70.00	13.00	R-05	56701	(1)	
43.00	75.00	10.00	R-02	38987	(2)	02658BRG
44.00	58.00	7.00	A-05	13059	(1)	02295BA
44.00	59.00	6.00	A-05	56700	(2)	
44.00	60.00	9.00	R-02	13061	(1)	
44.00	60.00	10.00	A-02	40296	(5)	02014BAGP
44.00	60.00	10.00	R-05	13063	(1)	01552BR
44.00	62.00	8.00	R-02	13064	(1)	
44.00	62.00	8.00	R-02	38988	(2)	
44.00	62.00	10.00	R-02	57332	(1)	
44.00	65.00	10.00	A-05	13068	(1)	
44.00	65.00	10.00	B-05	13069	(1)	
44.00	65.00	12.00	R-02	13067	(1)	
44.00	66.00	9.00	R-02	52079	(1)	
44.00	72.15	9.00	R-02	56198	(2)	
44.00	76.10	12.70	R-05	13077	(1)	00219BR
44.00	79.90	12.00	A-05	13079	(1)	00775BA
44.05	62.31	6.35	A-04	19482	(1)	
44.20	71.45	14.80	A-02	13154	(1)	01119BAG
44.30	60.00	7.00	R-05	14548	(1)	02378BR
44.30	81.00	12.50	R-05	13170	(1)	02196BR
44.40	53.95	8.50	A-02	13083	(1)	01858BAG
44.40	63.50	12.50	A-02	38990	(2)	02784BAGF
44.40	63.50	12.70	A-02	13119	(1)	02580BAG
44.40	73.00	9.00	R-02	13160	(1)	
44.45	53.98	4.76	A-04	19485	(1)	
44.45	55.40	9.50	R-05	38563	(8)	
44.45	57.15	6.35	A-05	13085	(1)	
44.45	57.15	7.93	R-05	19488	(1)	
44.45	57.15	7.94	A-04	19489	(1)	

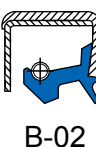

Eixo	Aloj.	Alt.	Modelo	Código CBV	T. M.	Conversão
44.45	59.33	6.35	R-05	13094	(1)	
44.45	61.91	7.95	R-05	13104	(1)	
44.45	61.91	9.53	R-05	13106	(1)	
44.45	61.92	11.90	B-05	13111	(1)	
44.45	61.92	11.91	R-02	47791	(1)	
44.45	63.50	7.94	B-05	13114	(1)	
44.45	63.50	7.94	R-05	13115	(1)	
44.45	63.50	9.53	R-05	13117	(1)	
44.45	63.50	9.53	R-05	42406	(7)	
44.45	65.00	12.70	A-04	19499	(1)	
44.45	66.67	12.70	R-02	56230	(2)	
44.45	66.68	9.53	B-05	13127	(1)	
44.45	68.26	6.35	A-04	19505	(1)	
44.45	69.06	10.32	A-05	55392	(1)	
44.45	69.85	7.94	A-05	13145	(1)	
44.45	70.00	13.00	B-05	38991	(2)	
44.45	73.03	11.91	R-05	13159	(1)	
44.50	54.00	4.80	A-05	13081	(1)	00749BA
44.50	57.00	9.00	B-02	13177	(1)	
44.50	57.15	9.40	R-05	13088	(1)	00734BR
44.50	57.40	9.40	R-02	13089	(1)	
44.50	58.70	10.00	R-02	57276	(2)	
44.50	60.30	9.50	R-05	13098	(1)	00877BR
44.50	61.90	9.50	A-02	13105	(1)	01859BAG
44.50	62.00	8.00	R-02	13176	(1)	
44.50	62.00	10.00	R-02	47323	(1)	
44.50	62.00	10.00	R-05	38989	(2)	
44.50	62.00	11.00	R-02	13113	(1)	01095BRG
44.50	62.00	11.00	R-05	13112	(1)	
44.50	62.10	12.70	A-05	57179	(1)	
44.50	63.40	4.80	R-04	19495	(1)	01306GR
44.50	63.50	9.50	R-05	40297	(5)	01845BRP
44.50	63.55	8.00	A-05	13116	(1)	02104BA
44.50	63.55	12.70	A-02	47447	(1)	00101BAG
44.50	63.55	12.70	B-05	13122	(1)	00101B
44.50	63.55	12.70	B-05	57341	(2)	
44.50	65.05	8.00	R-05	13124	(1)	01532BR
44.50	66.65	12.70	A-05	13129	(1)	00128BA
44.50	66.65	12.70	R-05	13130	(1)	00128BR
44.50	66.75	15.90	B-02	56915	(1)	
44.50	68.15	12.70	B-05	13134	(1)	00588B
44.50	68.20	15.90	R-02	13137	(1)	01679BRG
44.50	69.80	12.70	B-05	13147	(1)	00069B
44.50	70.00	9.50	R-05	13143	(1)	01656BR
44.50	73.00	12.00	B-05	13158	(1)	00276B
44.50	73.00	12.70	B-02	13161	(1)	02880BG
44.50	79.90	11.10	A-05	13169	(1)	00554BA
44.70	61.20	9.50	A-02	13178	(1)	00222BAG
44.80	61.30	12.00	A-05	13182	(1)	00012BA
44.80	61.45	12.00	R-05	13180	(1)	
44.80	62.30	12.00	R-05	10415	(1)	00097BRE
44.85	61.12	9.53	A-05	13179	(1)	
44.85	61.12	9.53	R-05	13181	(1)	
45.00	51.90	4.00	A-04	19527	(1)	02736GA
45.00	52.00	4.00	R-02	55479	(2)	
45.00	54.00	5.00	R-05	13187	(1)	

T. M. = Tipo de Material

(1) 70 NBR (2) 70 FPM (3) 80 NBR (4) 80 FPM (5) 70 ACM (6) 70 CR (7) 63 PG (8) 70 VMQ (9) 70 EPDM (10) 90 PU

Eixo	Aloj.	Alt.	Modelo	Código CBV	T. M.	Conversão
45.00	55.00	4.00	A-04	19528	(1)	
45.00	55.00	4.00	R-04	19529	(1)	02634GR
45.00	55.00	7.00	R-05	13186	(1)	
45.00	55.00	8.00	A-05	13189	(1)	
45.00	56.00	6.00	R-02	13190	(1)	
45.00	56.00	7.00	R-02	55642	(2)	
45.00	58.00	6.50	R-02	48739	(1)	
45.00	58.00	7.00	A-05	13194	(1)	
45.00	58.00	7.00	R-02	13197	(1)	
45.00	58.00	7.00	R-05	13193	(1)	
45.00	58.00	9.00	A-02	13196	(1)	
45.00	59.00	10.00	R-02	13195	(1)	
45.00	60.00	7.00	A-02	49461	(1)	
45.00	60.00	7.00	A-04	19530	(1)	
45.00	60.00	7.00	A-05	13198	(1)	
45.00	60.00	7.00	R-02	13200	(1)	00272BRG
45.00	60.00	7.00	R-05	38993	(2)	
45.00	60.00	7.50	R-05	47318	(1)	
45.00	60.00	8.00	A-05	13201	(1)	02175BA
45.00	60.00	8.00	R-02	40298	(1)	02175BRG
45.00	60.00	8.00	R-05	13202	(1)	
45.00	60.00	9.00	R-02	11378	(1)	01911BRG
45.00	60.00	9.00	R-02	38910	(2)	01911BRGF
45.00	60.00	10.00	B-05	13205	(1)	01738B
45.00	60.00	10.00	R-02	13204	(1)	01851BRG
45.00	60.00	10.00	R-05	13206	(1)	
45.00	60.00	12.00	R-05	13210	(1)	
45.00	60.25	7.00	R-02	56699	(2)	
45.00	62.00	7.00	A-05	13214	(1)	02169BA
45.00	62.00	7.00	R-02	53854	(1)	
45.00	62.00	7.00	R-05	57183	(1)	
45.00	62.00	8.00	R-02	13215	(1)	02110BRG
45.00	62.00	8.00	R-02	38995	(2)	
45.00	62.00	8.00	R-04	19532	(1)	01760GR
45.00	62.00	8.00	R-05	38564	(8)	
45.00	62.00	8.00	R-05	40299	(1)	02720BRGP
45.00	62.00	9.00	R-02	13218	(1)	02110BRG
45.00	62.00	9.00	R-05	13219	(1)	
45.00	62.00	10.00	A-05	13222	(1)	
45.00	62.00	10.00	B-02	13221	(1)	00063BG
45.00	62.00	10.00	R-02	38374	(1)	00063BRG
45.00	62.00	10.00	R-02	38565	(8)	
45.00	62.00	10.00	R-02	54849	(2)	
45.00	62.00	12.00	B-05	13227	(1)	
45.00	62.00	12.00	R-02	13225	(1)	
45.00	62.00	12.00	R-05	13228	(1)	
45.00	62.25	10.00	R-02	49224	(1)	
45.00	63.95	9.00	R-02	13232	(1)	01711BRG
45.00	64.00	9.00	R-05	13233	(1)	
45.00	64.95	12.00	R-05	13245	(1)	01344BR
45.00	65.00	8.00	R-02	13235	(1)	02324BRG
45.00	65.00	8.00	R-02	54003	(2)	02324BRG
45.00	65.00	10.00	R-02	56131	(2)	
45.00	65.00	10.00	R-05	13241	(1)	00359BR
45.00	65.00	10.00	RB-55	54179	(1)	
45.00	65.00	10.80	R-05	38996	(2)	



A-02



A-04

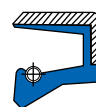

A-05



B-02

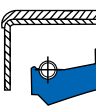

B-05



R-02



R-04



R-05



R-07

Eixo	Aloj.	Alt.	Modelo	Código CBV	T. M.	Conversão
45.00	65.00	12.00	B-02	13244	(1)	
45.00	65.10	10.00	A-05	38375	(6)	
45.00	65.10	10.00	R-02	13240	(1)	00359BRG
45.00	66.20	6.00	R-05	13248	(1)	01141BR
45.00	67.90	12.00	A-02	13253	(1)	01207BAG
45.00	68.00	10.00	R-05	13252	(1)	
45.00	68.00	10.00	R-05	57144	(2)	
45.00	68.10	12.00	R-02	13254	(1)	
45.00	69.00	13.00	R-05	13257	(1)	
45.00	70.00	10.00	A-05	13259	(1)	
45.00	70.00	10.00	B-05	13256	(1)	
45.00	70.00	10.00	R-05	56251	(1)	
45.00	70.00	12.00	A-05	13261	(1)	
45.00	70.00	14.00	B-05	13264	(1)	
45.00	72.00	8.00	R-02	13267	(1)	01553BR
45.00	72.00	8.00	R-02	38997	(2)	
45.00	72.00	8.00	R-05	13269	(1)	
45.00	72.00	9.00	R-05	19540	(1)	01553BR
45.00	72.00	10.00	A-05	13274	(1)	01906BA
45.00	72.00	10.00	R-02	13273	(1)	
45.00	72.00	10.00	R-07	54469	(1)	
45.00	72.00	12.00	B-05	13276	(1)	
45.00	72.00	12.00	R-02	13279	(1)	
45.00	72.00	12.00	R-05	13280	(1)	00509BR
45.00	72.30	13.00	R-05	57052	(1)	
45.00	73.12	13.00	A-02	13282	(1)	02395BAGG
45.00	75.00	8.00	R-02	13285	(1)	
45.00	75.00	8.00	R-02	54585	(2)	
45.00	75.00	8.00	R-05	13284	(1)	
45.00	75.00	10.00	R-05	54422	(1)	
45.00	76.00	12.00	R-05	56677	(1)	
45.00	80.00	8.00	R-05	13293	(1)	
45.00	80.00	10.00	B-02	13295	(1)	
45.00	80.00	10.00	R-02	13294	(1)	
45.00	80.00	10.00	R-05	50700	(1)	
45.00	80.00	13.00	A-02	13296	(1)	
45.00	82.00	10.00	R-05	13300	(1)	
45.00	82.00	10.00	R-07	38998	(2)	
45.00	85.00	10.00	A-05	13302	(1)	01038B
45.00	85.00	10.00	R-02	48843	(1)	
45.00	85.00	10.00	R-05	13303	(1)	
45.00	85.00	12.70	A-05	54103	(1)	
45.00	85.00	13.00	B-05	13305	(1)	01038B
45.00	100.00	10.00	A-05	13307	(1)	
45.60	48.75	3.20	A-04	19544	(1)	02522GA
46.00	56.00	4.00	R-02	13310	(1)	02591BRG
46.00	60.00	7.00	A-05	13312	(1)	
46.00	60.00	8.00	R-05	13313	(1)	
46.00	62.00	7.00	B-05	13314	(1)	00302B
46.00	62.00	8.00	B-05	13317	(1)	
46.00	64.00	8.00	R-05	13318	(1)	
46.00	65.00	10.00	R-05	13322	(1)	
46.00	65.50	7.00	R-02	13319	(1)	01764BRG
46.00	68.00	12.00	A-05	13325	(1)	
46.00	68.00	12.00	A-05	39000	(2)	07599BAP
46.00	80.00	6.00	A-04	19547	(1)	

T. M. = Tipo de Material

(1) 70 NBR (2) 70 FPM (3) 80 NBR (4) 80 FPM (5) 70 ACM (6) 70 CR (7) 63 PG (8) 70 VMQ (9) 70 EPDM (10) 90 PU

Eixo	Aloj.	Alt.	Modelo	Código CBV	T. M.	Conversão
46.04	67.47	9.53	R-05	39001	(2)	
46.20	80.00	10.00	B-02	13332	(1)	
46.30	66.60	6.40	A-05	13364	(1)	00849BA
46.46	62.41	6.35	R-04	81748	(3)	
46.46	62.41	6.35	R-04	81746	(4)	
46.70	62.00	9.00	R-02	19571	(2)	05353BRGF
46.83	80.96	11.11	R-05	13369	(1)	
47.00	58.00	7.00	R-02	13370	(1)	02024BRG
47.00	58.00	8.00	R-05	53855	(1)	
47.00	62.00	6.00	R-05	13372	(1)	
47.00	62.10	8.00	R-05	13375	(1)	01140BR
47.00	65.00	7.00	A-02	13377	(1)	02349BAG
47.00	65.00	12.00	B-05	13379	(1)	
47.00	70.00	13.00	R-05	53856	(1)	
47.00	79.00	8.00	A-02	13505	(1)	
47.00	90.00	10.00	R-02	56478	(1)	
47.50	76.05	9.50	A-04	19592	(1)	00848GA
47.60	57.15	5.00	A-05	39002	(2)	02558BAF
47.60	62.70	11.10	A-02	13392	(1)	00368BAG
47.60	63.50	11.00	A-02	38566	(8)	01955BAGS
47.60	63.50	11.00	R-02	56698	(2)	
47.60	63.55	9.70	A-02	47445	(1)	02990BAG
47.60	66.55	12.70	B-05	13404	(1)	00405B
47.60	66.80	9.50	R-05	13402	(1)	00567BR
47.60	69.80	12.70	B-05	13415	(1)	00155B
47.60	69.85	9.50	R-05	13474	(1)	01699BR
47.60	70.55	13.50	A-05	13419	(1)	01369BA
47.60	70.55	14.50	B-02	13388	(1)	00092BGOE
47.60	75.30	6.40	A-04	19590	(1)	00015GA
47.60	75.30	6.40	R-04	47402	(1)	00015GR
47.60	79.25	10.00	R-05	13432	(1)	01519BR
47.60	82.80	11.00	B-05	19599	(1)	01460B
47.60	90.00	8.00	R-02	13387	(1)	
47.63	66.68	12.70	B-05	13406	(1)	
47.63	69.85	12.70	B-02	13413	(1)	
47.70	62.10	8.00	R-05	13439	(1)	00264BR
47.70	65.00	8.00	R-05	13398	(1)	02055BR
47.70	65.00	8.00	R-05	51379	(2)	02055BRF
47.70	72.95	12.00	B-05	13423	(1)	00674B
47.80	60.90	6.40	A-05	13440	(1)	00220BAE
48.00	60.00	10.00	R-02	57333	(1)	
48.00	62.00	7.00	A-02	13445	(1)	
48.00	62.00	7.00	R-02	13444	(1)	
48.00	62.00	8.00	A-05	13447	(1)	00566BA
48.00	62.00	8.00	R-02	56319	(8)	
48.00	62.00	8.00	R-05	13446	(1)	
48.00	65.00	10.00	B-05	13457	(1)	00527B
48.00	65.00	10.00	R-02	13454	(1)	
48.00	65.00	12.00	B-02	13460	(1)	01840BGO
48.00	65.00	12.00	B-05	13461	(1)	
48.00	65.10	7.00	R-02	13453	(1)	01147BRG
48.00	66.00	11.00	R-02	40302	(5)	02721BRGP
48.00	66.10	12.00	R-05	13471	(1)	01793BR
48.00	68.00	10.00	R-02	13468	(1)	
48.00	69.00	10.00	A-05	13542	(2)	07485BAF
48.00	69.00	12.00	A-05	13472	(1)	

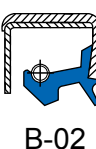

Eixo	Aloj.	Alt.	Modelo	Código CBV	T. M.	Conversão
48.00	70.00	9.00	R-02	51400	(1)	
48.00	70.00	12.00	R-02	56697	(1)	
48.00	71.00	16.00	A-02	20249	(1)	
48.00	72.00	7.00	R-05	13482	(1)	
48.00	72.00	8.00	A-05	13484	(1)	
48.00	72.00	8.00	R-02	48860	(1)	
48.00	72.00	10.00	R-02	13485	(1)	00161BRG
48.00	72.00	10.00	R-05	13486	(1)	01902BR
48.00	72.00	10.00	R-05	39004	(2)	
48.00	72.00	12.00	R-02	13488	(1)	
48.00	72.00	13.00	R-02	56695	(1)	
48.00	72.10	7.00	R-02	13479	(1)	00522BRG
48.00	75.00	8.00	A-05	39003	(2)	02723BAF
48.00	80.00	8.10	B-05	13494	(1)	
48.00	80.00	10.00	R-05	13496	(1)	
48.00	80.00	12.00	B-05	13498	(1)	
48.00	82.00	5.00	R-05	54318	(1)	
48.50	71.00	16.00	R-05	13511	(1)	
49.00	65.00	8.00	R-02	56696	(1)	
49.00	65.00	10.00	A-02	13513	(1)	01241BAG
49.00	65.00	10.00	A-05	13512	(1)	
49.00	73.00	14.00	R-05	39005	(2)	
49.00	75.00	11.00	R-05	13522	(1)	01017BR
49.20	63.50	9.50	A-05	13530	(1)	00157BA
49.20	65.00	8.00	R-02	13534	(1)	00708BRG
49.20	65.00	8.00	R-05	13514	(1)	00708BR
49.20	66.67	11.11	B-02	19612	(1)	
49.20	69.90	9.50	A-05	13546	(1)	00072BA
49.20	69.90	9.50	R-05	13547	(1)	
49.20	75.90	16.00	B-05	13655	(1)	
49.20	76.05	12.70	B-05	13559	(1)	00291B
49.20	76.05	12.70	R-05	13560	(1)	00291BR
49.20	76.20	12.70	A-05	13525	(1)	
49.20	76.46	12.00	R-02	56243	(2)	
49.20	76.46	12.70	R-02	56317	(1)	
49.20	79.35	12.50	R-05	13564	(1)	01994BR
49.20	80.90	11.00	B-05	13567	(1)	00229B
49.21	66.68	9.13	A-05	13539	(1)	
49.21	66.68	9.13	B-05	13538	(1)	
49.21	68.26	12.70	A-05	13516	(1)	01262BAG
49.21	84.93	11.91	A-05	13571	(1)	
49.23	66.78	7.92	R-02	56464	(1)	
49.30	72.00	8.00	R-05	13576	(1)	
49.50	59.00	7.00	R-05	13579	(1)	
49.50	69.80	7.00	R-02	13578	(1)	
50.00	58.00	4.00	A-04	19624	(1)	01973GA
50.00	58.00	6.00	A-04	19625	(1)	
50.00	60.00	7.00	B-05	55406	(7)	
50.00	60.00	10.00	R-02	54561	(1)	
50.00	62.00	5.00	R-02	13588	(1)	
50.00	62.00	6.00	R-02	46679	(1)	
50.00	62.00	7.00	A-05	13584	(1)	
50.00	62.00	7.00	R-02	13586	(1)	
50.00	62.00	7.00	R-05	13587	(1)	
50.00	62.00	7.00	R-05	54790	(1)	
50.00	62.00	8.00	A-05	13589	(1)	

T. M. = Tipo de Material

(1) 70 NBR (2) 70 FPM (3) 80 NBR (4) 80 FPM (5) 70 ACM (6) 70 CR (7) 63 PG (8) 70 VMQ (9) 70 EPDM (10) 90 PU

Eixo	Aloj.	Alt.	Modelo	Código CBV	T. M.	Conversão
50.00	62.00	10.00	B-05	13592	(1)	
50.00	62.00	13.00	R-02	55716	(2)	
50.00	64.00	8.00	R-02	18350	(1)	
50.00	64.00	10.00	R-02	13594	(1)	
50.00	65.00	8.00	A-02	48866	(1)	
50.00	65.00	8.00	A-05	56637	(2)	
50.00	65.00	8.00	B-05	13597	(1)	
50.00	65.00	8.00	R-02	13599	(1)	01422BRG
50.00	65.00	8.00	R-02	13690	(2)	01422BRGF
50.00	65.00	8.00	R-05	13598	(1)	01422BR
50.00	65.00	8.00	R-05	39006	(2)	01422BRF
50.00	65.00	8.00	R-05	38572	(8)	01422BRS
50.00	65.00	8.50	R-02	13600	(1)	01783BRG
50.00	65.00	10.00	B-05	13602	(1)	01740B
50.00	65.00	10.00	R-02	56694	(1)	
50.00	65.00	10.00	R-05	13603	(1)	
50.00	65.00	10.00	R-05	56260	(2)	
50.00	66.00	8.00	R-02	13604	(1)	
50.00	66.00	8.00	R-02	52187	(2)	
50.00	68.00	8.00	A-05	53857	(1)	
50.00	68.00	8.00	R-02	54473	(1)	
50.00	68.00	8.00	R-02	38573	(8)	
50.00	68.00	8.50	R-04	19630	(1)	01847GR
50.00	68.00	9.00	A-02	13702	(1)	
50.00	68.00	9.00	R-02	13611	(1)	02108BRG
50.00	68.00	10.00	A-05	53821	(1)	
50.00	68.00	10.00	B-05	13612	(1)	
50.00	68.00	10.00	R-02	13615	(1)	
50.00	68.00	10.00	R-02	39008	(2)	
50.00	68.00	10.00	R-05	13613	(1)	01340BR
50.00	68.00	13.00	R-02	13619	(1)	
50.00	69.60	12.70	B-05	13693	(1)	00653B
50.00	70.00	8.00	R-05	13622	(1)	
50.00	70.00	8.00	R-05	54667	(2)	
50.00	70.00	10.00	R-02	13623	(1)	
50.00	70.00	10.00	R-05	13625	(1)	00946BR
50.00	70.00	10.00	R-05	53725	(2)	
50.00	70.00	11.00	R-05	46495	(1)	
50.00	70.00	12.00	A-02	13627	(1)	01807BAG
50.00	70.00	12.00	A-02	56276	(2)	
50.00	70.00	12.00	A-05	13631	(1)	
50.00	70.00	12.00	B-05	13629	(1)	
50.00	70.00	12.00	R-05	39012	(2)	
50.00	71.85	12.00	R-05	13644	(1)	00162BR
50.00	72.00	7.00	R-02	13632	(1)	
50.00	72.00	7.00	R-2S	49750	(2)	
50.00	72.00	8.00	A-05	13635	(1)	
50.00	72.00	8.00	R-02	38574	(8)	
50.00	72.00	8.00	R-2S	13636	(1)	
50.00	72.00	10.00	B-05	13639	(1)	
50.00	72.00	10.00	R-02	13638	(1)	
50.00	72.00	10.00	R-05	39013	(2)	
50.00	72.00	12.00	B-05	13645	(1)	
50.00	72.00	12.00	R-02	13643	(1)	01861BRG
50.00	72.00	12.00	R-02	39014	(2)	
50.00	72.08	10.00	R-05	13640	(1)	00834BR

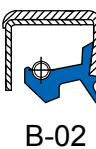

Eixo	Aloj.	Alt.	Modelo	Código CBV	T. M.	Conversão
50.00	73.15	12.70	B-05	13694	(1)	
50.00	74.00	12.00	B-05	13648	(1)	
50.00	75.00	6.00	R-05	13650	(1)	
50.00	75.00	6.00	R-05	39015	(2)	
50.00	75.00	8.00	A-05	51992	(1)	
50.00	75.00	10.00	R-02	39016	(2)	
50.00	75.00	10.00	R-05	13651	(1)	
50.00	75.00	12.00	R-05	13653	(1)	
50.00	75.00	12.00	RB-55	54180	(1)	
50.00	75.00	13.00	R-02	56693	(2)	
50.00	76.00	12.00	R-05	13656	(1)	
50.00	78.00	10.00	R-05	13658	(1)	
50.00	80.00	7.00	R-02	51813	(2)	
50.00	80.00	7.00	R-05	53709	(1)	
50.00	80.00	8.00	R-05	13659	(1)	
50.00	80.00	10.00	A-05	13662	(1)	
50.00	80.00	10.00	B-05	13663	(1)	
50.00	80.00	10.00	R-02	46715	(1)	
50.00	80.00	10.00	R-05	56196	(2)	
50.00	80.00	13.00	B-05	13670	(1)	
50.00	80.00	13.00	R-05	13671	(1)	
50.00	82.00	10.00	R-07	39018	(2)	
50.00	85.00	13.00	R-05	13676	(1)	
50.00	85.00	13.00	R-07	39017	(2)	
50.00	87.00	12.70	A-02	13678	(1)	01855BAG
50.00	90.00	10.00	A-02	13684	(1)	
50.00	90.00	10.00	A-05	13682	(1)	
50.00	90.00	10.00	R-02	13681	(1)	
50.00	90.00	12.00	B-05	13683	(1)	
50.00	110.00	12.00	R-02	13689	(1)	
50.80	60.20	6.30	A-04	19646	(1)	
50.80	63.50	6.35	R-04	19647	(1)	
50.80	63.50	7.94	R-05	13703	(1)	
50.80	65.05	12.70	A-02	13711	(1)	02262BAG
50.80	65.10	12.70	A-04	13706	(1)	01671GA
50.80	69.80	12.70	B-05	13722	(1)	00468B
50.80	69.85	11.00	R-02	13724	(5)	05308BRGP
50.80	71.90	11.90	B-05	13729	(1)	01878B
50.80	73.00	12.70	B-02	13731	(1)	00630BG
50.80	73.00	12.70	B-05	47577	(1)	00630B
50.80	73.00	12.70	R-05	54355	(1)	00630BR
50.80	73.03	7.94	R-05	13728	(1)	
50.80	75.40	12.70	R-02	53577	(1)	
50.80	76.20	7.94	A-02	13737	(1)	
50.80	76.20	7.94	A-02	56177	(2)	
50.80	76.20	7.94	R-02	56736	(1)	
50.80	76.20	9.53	B-05	13738	(1)	
50.80	76.20	9.53	B-05	38376	(6)	
50.80	76.20	11.11	A-02	13741	(1)	
50.80	76.20	12.70	R-05	13742	(1)	00048BR
50.80	79.50	11.10	A-05	19671	(1)	
50.80	79.90	10.00	A-05	13751	(1)	00752BA
50.80	80.00	12.70	B-05	13753	(1)	00660B
50.80	81.00	11.90	B-02	13754	(1)	00274BGO
50.90	69.80	9.50	R-02	13720	(1)	00586BRG
50.90	69.80	9.50	R-05	13721	(1)	00586BR

T. M. = Tipo de Material

(1) 70 NBR (2) 70 FPM (3) 80 NBR (4) 80 FPM (5) 70 ACM (6) 70 CR (7) 63 PG (8) 70 VMQ (9) 70 EPDM (10) 90 PU

Eixo	Aloj.	Alt.	Modelo	Código CBV	T. M.	Conversão
51.00	58.00	4.20	A-04	12396	(1)	02342GA
51.00	76.00	6.00	R-05	13766	(1)	
52.00	68.00	7.00	R-02	56839	(1)	
52.00	68.00	8.00	A-05	13775	(1)	
52.00	68.00	10.00	R-05	39019	(2)	
52.00	72.00	10.00	A-02	13787	(1)	
52.00	72.00	10.00	B-05	39020	(2)	
52.00	72.00	10.00	R-05	13788	(1)	
52.00	72.00	10.00	R-05	39156	(2)	
52.00	72.00	10.00	R-07	38575	(8)	
52.00	72.00	12.00	A-02	13791	(1)	01950BAG
52.00	72.00	12.00	A-02	12681	(2)	00047BAGF
52.00	72.00	12.00	B-05	13792	(1)	00047B
52.00	72.00	12.00	R-05	13793	(1)	
52.00	75.00	10.00	R-05	13796	(1)	
52.00	75.00	12.00	B-05	13798	(1)	
52.00	75.00	12.00	R-05	13652	(1)	
52.00	76.00	7.00	R-02	13799	(1)	
52.00	80.00	12.00	B-02	51380	(1)	
52.00	80.05	10.00	R-05	13802	(1)	00867BR
52.00	85.00	10.00	R-05	54674	(1)	
52.00	85.00	14.00	R-05	54673	(1)	
52.00	100.00	10.00	A-02	56691	(1)	
52.30	76.20	12.00	B-02	55546	(2)	
52.39	76.20	9.50	R-02	56321	(1)	
52.39	76.20	12.70	R-05	56692	(1)	
52.40	68.00	10.50	R-05	13841	(1)	01187BR
52.40	69.80	12.70	B-05	13811	(1)	00843B
52.40	72.10	11.40	B-05	13839	(1)	00004B
52.40	72.10	11.40	R-05	47400	(1)	00004BR
52.40	76.10	7.90	A-05	13820	(1)	00974BA
52.40	76.20	7.50	R-02	54181	(1)	95//
52.40	76.35	7.90	R-04	13821	(1)	
52.40	80.95	11.50	B-05	13829	(1)	00005B
53.00	63.72	7.25	A-04	20256	(1)	
53.00	65.00	5.00	A-02	13846	(1)	
53.00	65.00	5.00	A-05	19696	(1)	
53.00	65.00	5.00	R-04	19695	(1)	
53.00	68.00	10.00	R-02	13844	(1)	
53.00	75.00	12.00	B-05	13852	(1)	00838B
53.00	82.00	7.50	A-04	48901	(1)	07023GA
53.50	90.00	5.00	R-05	13856	(1)	
53.80	77.70	12.70	A-05	13857	(1)	00006BA
53.90	73.00	12.70	B-05	13868	(1)	00037B
53.90	76.15	12.70	A-05	13878	(1)	00093BA
53.90	81.10	12.00	R-02	19705	(1)	00231BRG
53.98	73.03	9.53	A-02	54000	(1)	
53.98	73.03	9.53	A-02	56690	(2)	
53.98	73.03	11.91	R-05	13867	(1)	
53.98	73.30	9.53	R-02	56270	(2)	
53.98	76.20	12.70	R-05	13880	(1)	
53.98	84.93	11.91	A-05	13901	(1)	
53.98	84.93	11.91	B-05	13900	(1)	
54.00	65.00	8.00	A-05	13912	(1)	01278BA
54.00	72.00	8.00	R-05	51037	(1)	00563BR
54.00	72.00	10.00	R-02	13917	(1)	

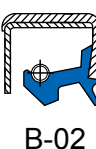

Eixo	Aloj.	Alt.	Modelo	Código CBV	T. M.	Conversão
54.00	72.00	10.00	R-05	13919	(1)	
54.00	73.00	9.50	R-02	13862	(1)	02197BRG
54.00	73.00	11.00	A-02	40306	(5)	02207BAGP
54.00	76.00	8.00	R-02	13872	(1)	01825BRG
54.00	76.20	12.70	A-02	13876	(1)	01864BAG
54.00	77.70	11.00	R-02	39021	(2)	660BRGF
54.00	77.75	19.00	B-02	13886	(1)	01012BGO
54.00	79.35	9.50	B-02	40336	(5)	02287BGP
54.00	79.35	12.70	A-02	13887	(1)	00436BAG
54.00	79.35	12.70	B-05	13920	(1)	00436B
54.00	85.00	10.00	R-05	13925	(1)	
54.00	90.00	12.50	A-02	40307	(5)	02205BAGP
54.10	73.00	8.50	A-02	20237	(1)	01930BAG
55.00	62.90	5.00	A-04	13930	(1)	02847GA
55.00	65.00	5.00	R-04	13932	(1)	02635GR
55.00	66.00	8.00	R-04	19731	(1)	
55.00	68.00	4.00	R-04	19732	(1)	01035GR
55.00	68.00	8.00	R-02	13935	(1)	
55.00	68.00	8.00	R-05	13936	(1)	
55.00	68.00	10.00	A-02	49356	(1)	
55.00	68.00	10.00	R-02	52082	(1)	
55.00	70.00	8.00	A-05	13939	(1)	
55.00	70.00	8.00	A-05	56852	(2)	
55.00	70.00	8.00	B-05	13940	(1)	
55.00	70.00	8.00	R-02	13938	(1)	
55.00	70.00	8.00	R-02	39023	(2)	
55.00	70.00	8.00	R-05	13941	(1)	01181BR
55.00	70.00	10.00	R-02	56688	(8)	
55.00	70.00	10.00	R-05	13945	(1)	
55.00	70.00	10.00	R-05	46588	(2)	
55.00	70.00	11.00	R-02	13946	(1)	
55.00	70.00	13.00	R-05	53858	(1)	
55.00	70.10	11.50	R-05	13949	(1)	01557BR
55.00	72.00	8.00	A-05	13952	(1)	
55.00	72.00	8.00	R-02	13954	(1)	
55.00	72.00	8.00	R-02	39025	(2)	
55.00	72.00	9.00	R-02	13953	(1)	02111BRG
55.00	72.00	10.00	A-02	13960	(1)	
55.00	72.00	10.00	B-05	13957	(1)	
55.00	72.00	10.00	R-02	39024	(2)	
55.00	72.00	10.00	R-02	38577	(8)	01969BRGS
55.00	72.00	10.00	R-05	13951	(1)	01550BR
55.00	72.00	10.00	R-05	40308	(5)	01550BRP
55.00	72.00	10.00	R-07	39027	(2)	
55.00	73.00	9.50	R-02	54477	(2)	
55.00	73.00	10.00	R-02	39026	(1)	
55.00	75.00	8.00	A-02	13970	(1)	
55.00	75.00	10.00	A-05	13969	(1)	
55.00	75.00	10.00	R-02	13968	(1)	
55.00	75.00	10.00	R-02	39028	(2)	
55.00	75.00	10.00	R-05	13971	(1)	00804BR
55.00	75.00	12.00	B-05	13974	(1)	00620B
55.00	75.00	12.00	R-05	13975	(1)	
55.00	75.00	12.00	R-05	57291	(6)	
55.00	76.00	12.00	A-05	13978	(1)	01247BA
55.00	76.00	12.00	R-02	56954	(1)	

T. M. = Tipo de Material

(1) 70 NBR (2) 70 FPM (3) 80 NBR (4) 80 FPM (5) 70 ACM (6) 70 CR (7) 63 PG (8) 70 VMQ (9) 70 EPDM (10) 90 PU

Eixo	Aloj.	Alt.	Modelo	Código CBV	T. M.	Conversão
55.00	78.00	10.00	R-05	13980	(1)	
55.00	80.00	8.00	A-05	13985	(1)	
55.00	80.00	8.00	R-02	13987	(1)	02529BRG
55.00	80.00	8.00	R-05	13986	(1)	
55.00	80.00	10.00	A-05	54104	(1)	
55.00	80.00	10.00	B-05	13989	(1)	
55.00	80.00	10.00	R-02	13990	(1)	
55.00	80.00	10.00	R-02	39029	(2)	
55.00	80.00	10.00	R-05	13997	(1)	00459BR
55.00	80.00	10.00	R-05	39030	(2)	
55.00	80.00	12.00	B-05	13991	(1)	
55.00	80.00	12.00	R-05	54161	(1)	
55.00	80.00	13.00	A-02	56686	(1)	
55.00	80.00	13.00	B-05	13996	(1)	
55.00	80.00	13.00	R-02	55197	(1)	00498BRG
55.00	80.00	13.00	R-05	13995	(1)	00498BR
55.00	80.00	13.00	R-05	13995	(1)	00498BR
55.00	80.20	12.70	R-02	56687	(1)	
55.00	82.50	12.70	A-05	19739	(1)	
55.00	85.00	8.00	R-05	13999	(1)	
55.00	85.00	10.00	B-05	14000	(1)	
55.00	85.00	13.00	R-05	14003	(1)	01180BR
55.00	90.00	8.00	A-02	56685	(1)	
55.00	90.00	8.00	R-02	54145	(1)	
55.00	90.00	10.00	A-05	14006	(1)	00793BA
55.00	90.00	10.00	A-05	56221	(2)	
55.00	90.00	10.00	R-02	14008	(1)	
55.00	90.00	12.50	B-05	14010	(1)	00964B
55.00	90.00	13.00	A-02	14009	(1)	
55.00	95.00	8.00	R-02	50902	(1)	
55.00	100.00	10.00	R-02	14011	(1)	01669BRG
55.00	100.00	10.00	R-02	56266	(2)	
55.00	100.00	10.00	R-02	56311	(8)	
55.00	100.00	12.50	R-05	14014	(1)	01669BR
55.00	100.00	13.00	R-05	14058	(1)	
55.00	101.60	10.00	A-05	14013	(1)	00776BA
55.10	82.00	10.00	A-04	19736	(1)	01637GA
55.40	76.15	12.70	A-02	14019	(1)	02415BAG
55.50	80.90	15.50	A-02	14028	(1)	02181BAG
55.56	76.20	9.53	B-05	14018	(1)	
55.56	79.38	11.11	B-05	14021	(1)	
56.00	72.00	8.00	A-05	14044	(1)	
56.00	72.00	8.00	R-05	14045	(1)	
56.00	75.00	12.00	R-05	14047	(1)	
56.00	80.00	8.00	R-05	14049	(1)	
56.00	82.60	8.50	R-02	56181	(1)	
56.00	85.00	8.00	R-05	55566	(1)	
56.00	85.00	13.00	R-05	14055	(1)	00919BR
56.00	100.00	10.00	B-05	14057	(1)	
56.00	100.00	10.00	R-05	20223	(1)	
56.40	63.50	11.11	R-05	53734	(1)	
57.00	69.80	6.40	A-05	14072	(1)	00456BA
57.00	71.00	9.00	R-02	14043	(2)	05352BRGF
57.00	75.00	9.00	R-05	14062	(1)	
57.00	78.40	10.00	R-02	51385	(1)	
57.00	82.30	9.50	A-05	14101	(1)	02381BA

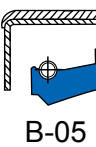
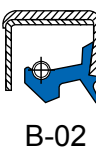

Eixo	Aloj.	Alt.	Modelo	Código CBV	T. M.	Conversão
57.00	82.50	9.00	R-02	56681	(2)	
57.00	83.00	12.00	A-05	53859	(1)	
57.00	85.00	12.00	A-05	40309	(5)	02236BAP
57.10	76.10	11.00	A-02	14081	(1)	02067BAG
57.10	76.20	9.50	A-05	14078	(1)	
57.10	76.20	12.70	R-02	14083	(1)	02193BRG
57.10	80.00	13.00	B-05	14064	(1)	00735B
57.15	76.20	4.76	R-02	55184	(1)	
57.15	76.21	12.70	R-05	38578	(8)	
57.15	77.79	11.11	A-02	14087	(1)	
57.15	79.38	9.53	A-05	14093	(1)	
57.15	80.17	11.11	R-05	56684	(1)	
57.15	80.96	6.35	A-04	56682	(1)	
57.15	80.96	12.70	R-05	14098	(1)	
57.15	80.96	12.70	R-05	56683	(2)	
57.15	82.55	12.70	R-05	14104	(1)	
57.15	82.57	9.50	R-02	56254	(1)	
57.15	84.93	12.70	B-05	14113	(1)	
57.15	85.73	11.91	R-05	14115	(1)	
57.15	88.90	12.70	R-05	14121	(1)	
57.20	73.00	8.00	A-02	14074	(1)	02066BAG
57.20	76.00	12.70	A-02	14135	(1)	
57.20	76.10	12.70	B-05	14134	(1)	00013B
57.20	77.75	10.00	R-02	40310	(5)	02667BRGP
57.20	77.80	11.10	R-02	14139	(1)	00067BRG
57.20	79.30	12.70	B-05	14094	(1)	00146B
57.20	80.00	12.70	B-05	14097	(1)	00109B
57.20	82.50	9.50	A-02	14100	(1)	02103BAG
57.20	82.50	12.70	A-05	14071	(1)	00321BA
57.20	82.55	6.50	A-04	19764	(1)	02316GA
57.20	85.00	12.70	B-05	14066	(1)	00273B
57.20	85.00	12.70	B-05	14066	(1)	00273B
57.20	92.00	18.00	B-02	14124	(1)	00014BGO
57.30	76.20	9.50	A-02	14076	(1)	01862BRAG
57.30	76.20	12.70	R-02	14140	(1)	00013BRG
57.30	84.00	8.00	A-05	14136	(1)	00188BA
57.60	82.60	9.50	A-02	56264	(2)	
57.94	80.00	12.00	R-02	38641	(8)	
58.00	70.00	10.00	R-02	56566	(2)	
58.00	72.00	8.00	A-05	57087	(1)	
58.00	72.00	8.00	B-05	14138	(1)	
58.00	72.00	8.00	R-02	54665	(1)	
58.00	72.00	10.00	A-05	54100	(1)	
58.00	72.00	12.00	R-05	14142	(1)	
58.00	74.00	10.00	R-02	39034	(2)	05305BRGF
58.00	75.00	8.00	R-05	14144	(1)	
58.00	75.00	9.00	R-02	14145	(1)	02112BRG
58.00	75.00	12.00	A-02	14147	(1)	02100BAG
58.00	75.00	12.00	R-05	14149	(1)	
58.00	80.00	10.00	R-02	14159	(1)	
58.00	80.00	10.00	R-05	14156	(1)	
58.00	80.00	12.00	R-02	14160	(1)	02326BRG
58.00	80.00	12.00	R-02	47721	(5)	02326BRGP
58.00	80.00	13.00	R-02	38378	(6)	
58.00	83.00	13.00	R-05	14168	(1)	
58.00	85.00	10.00	B-05	14169	(1)	

T. M. = Tipo de Material

(1) 70 NBR (2) 70 FPM (3) 80 NBR (4) 80 FPM (5) 70 ACM (6) 70 CR (7) 63 PG (8) 70 VMQ (9) 70 EPDM (10) 90 PU

Eixo	Aloj.	Alt.	Modelo	Código CBV	T. M.	Conversão
58.00	85.00	13.00	A-02	14170	(1)	01798BAG
58.00	85.00	13.00	B-05	56509	(1)	
58.00	90.00	13.00	B-05	14172	(1)	
58.20	82.80	9.50	R-02	56472	(1)	
58.70	79.35	9.60	R-05	14177	(1)	01995BR
58.70	84.05	9.50	A-04	19791	(1)	00010GA
58.70	85.00	8.00	A-05	14185	(1)	00070BA
58.70	85.00	8.00	A-05	39032	(2)	
58.70	89.03	25.40	R-02	55549	(1)	
58.74	76.20	11.11	A-05	14173	(1)	
58.74	76.20	11.11	B-05	14174	(1)	
58.74	88.90	12.70	B-05	14190	(1)	
58.74	88.90	25.40	B-05	56207	(1)	
58.74	88.90	25.40	R-05	56515	(1)	
59.00	80.00	10.00	B-05	54123	(2)	
59.00	80.50	9.00	R-05	14200	(1)	
59.00	83.00	9.00	R-05	14261	(1)	
59.50	80.00	10.00	R-02	49945	(1)	
59.50	85.60	12.00	B-05	14203	(1)	00547B
60.00	70.00	7.00	A-04	19796	(1)	
60.00	70.00	7.00	A-05	14206	(1)	
60.00	70.00	10.00	A-05	14208	(1)	
60.00	70.00	25.00	R-02	56293	(2)	
60.00	72.00	6.00	R-04	19798	(1)	02636GR
60.00	72.00	8.00	R-02	39033	(2)	
60.00	72.00	8.00	R-05	14211	(1)	
60.00	74.00	4.00	R-04	52083	(1)	
60.00	74.00	7.00	R-05	38580	(1)	
60.00	75.00	8.00	A-02	14217	(1)	
60.00	75.00	8.00	A-05	14218	(1)	
60.00	75.00	8.00	A-05	56851	(2)	
60.00	75.00	8.00	B-02	56280	(2)	
60.00	75.00	8.00	R-02	14216	(1)	
60.00	75.00	8.00	R-02	38579	(8)	
60.00	75.00	8.00	R-02	50962	(2)	
60.00	75.00	8.00	R-05	14220	(1)	00501BR
60.00	75.00	10.00	A-05	56669	(1)	
60.00	75.00	10.00	R-02	14223	(1)	
60.00	75.00	13.00	R-05	14221	(1)	
60.00	76.20	11.10	R-05	48784	(2)	05126BRF
60.00	77.00	11.00	R-05	14227	(1)	
60.00	78.05	8.80	A-02	14235	(1)	
60.00	80.00	7.00	R-02	56667	(1)	
60.00	80.00	7.00	R-05	54451	(1)	
60.00	80.00	7.00	R-05	56397	(2)	
60.00	80.00	8.00	A-05	14239	(1)	
60.00	80.00	8.00	R-05	14240	(1)	
60.00	80.00	8.00	R-05	39035	(2)	
60.00	80.00	10.00	R-02	14241	(1)	00223BRG
60.00	80.00	10.00	R-02	38581	(8)	
60.00	80.00	10.00	R-02	46804	(2)	
60.00	80.00	10.00	R-05	14246	(1)	00223BR
60.00	80.00	10.00	R-05	39037	(2)	02955BRF
60.00	80.00	10.00	R-05	38583	(8)	
60.00	80.00	10.00	R-07	38392	(6)	
60.00	80.00	12.00	A-02	14249	(1)	01392BAG

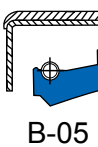
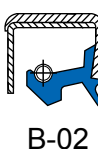

Eixo	Aloj.	Alt.	Modelo	Código CBV	T. M.	Conversão
60.00	80.00	12.00	B-05	38379	(6)	
60.00	80.00	12.00	R-02	56614	(1)	
60.00	80.00	12.00	R-05	39039	(2)	
60.00	80.00	13.00	A-02	14244	(1)	
60.00	80.00	13.00	B-05	14256	(1)	
60.00	80.00	13.00	B-05	39038	(2)	
60.00	80.00	13.00	R-05	14257	(1)	00818BR
60.00	82.00	10.00	R-05	55568	(2)	
60.00	82.00	12.00	R-02	14259	(1)	01841BRG
60.00	82.00	12.00	R-05	14260	(1)	00977BR
60.00	82.00	12.00	R-05	39040	(2)	
60.00	82.00	12.00	R-07	38999	(2)	
60.00	85.00	8.00	R-02	14263	(1)	
60.00	85.00	8.00	R-02	39041	(2)	
60.00	85.00	8.00	R-05	14264	(1)	
60.00	85.00	8.00	R-05	39042	(2)	
60.00	85.00	10.00	R-02	14268	(1)	
60.00	85.00	11.00	R-05	57181	(2)	
60.00	85.00	13.00	B-05	54124	(1)	
60.00	85.00	13.00	R-05	54163	(1)	
60.00	89.50	11.50	R-05	14229	(1)	
60.00	90.00	8.00	R-02	50689	(1)	
60.00	90.00	8.00	R-05	14279	(1)	02685BR
60.00	90.00	10.00	A-02	14280	(1)	
60.00	90.00	10.00	A-05	14282	(1)	
60.00	90.00	10.00	R-02	14281	(1)	
60.00	90.00	10.00	R-05	14283	(1)	00517BR
60.00	90.00	12.00	B-02	14285	(1)	
60.00	90.00	13.00	A-02	14288	(1)	
60.00	95.00	8.00	R-02	50903	(1)	
60.00	95.00	10.00	R-05	14293	(1)	
60.00	95.00	13.00	B-05	14294	(1)	
60.00	100.00	10.00	R-05	14296	(1)	
60.00	110.00	12.00	A-02	56670	(1)	
60.00	110.00	12.00	R-02	14299	(1)	
60.20	85.75	9.50	A-05	14300	(1)	01755BA
60.30	79.35	9.50	A-02	14311	(1)	02077BAG
60.30	79.40	12.00	A-02	40311	(5)	02206BAGP
60.30	82.50	9.25	A-05	54658	(5)	
60.30	82.50	11.00	A-05	40312	(5)	02116BAP
60.30	85.00	12.00	B-05	14328	(1)	00371B
60.30	85.05	6.40	A-02	19812	(1)	
60.30	85.05	6.40	A-05	19810	(1)	01345BA
60.30	88.40	11.00	B-05	50353	(1)	00021B
60.30	88.40	12.70	A-05	14341	(1)	
60.30	90.00	12.50	A-02	40313	(5)	02204BAGP
60.30	92.00	12.00	A-02	14302	(1)	00334BAG
60.32	84.93	12.70	R-05	14270	(1)	01194BR
60.32	88.34	12.70	B-02	48951	(1)	00021B
60.32	92.07	11.90	B-05	56863	(1)	
60.33	76.20	6.35	A-05	14305	(1)	
60.33	76.20	9.53	A-05	14304	(1)	
60.33	79.05	9.53	R-02	56240	(2)	
60.33	79.38	9.53	R-02	56671	(2)	
60.33	82.55	12.70	R-05	14323	(1)	
60.33	84.93	6.35	A-04	19808	(1)	

T. M. = Tipo de Material

(1) 70 NBR (2) 70 FPM (3) 80 NBR (4) 80 FPM (5) 70 ACM (6) 70 CR (7) 63 PG (8) 70 VMQ (9) 70 EPDM (10) 90 PU

Eixo	Aloj.	Alt.	Modelo	Código CBV	T. M.	Conversão
60.33	85.33	12.70	R-05	14334	(1)	
60.33	88.90	12.70	R-05	14350	(1)	
60.40	79.35	9.30	R-02	38584	(8)	01050BRGS
60.40	79.35	9.30	R-05	14312	(1)	01050BR
60.40	79.40	9.30	R-02	39043	(2)	02578BRGF
60.50	77.80	10.00	R-02	56231	(2)	
61.00	85.00	7.00	R-05	14370	(1)	
61.00	85.30	9.50	A-05	38380	(6)	
61.90	79.95	10.00	B-05	14404	(1)	01828B
62.00	72.92	7.25	A-04	20257	(1)	
62.00	80.00	10.00	A-05	14405	(1)	
62.00	80.00	10.00	B-02	14403	(1)	
62.00	80.00	10.00	R-05	55393	(1)	
62.00	80.00	10.00	R-05	55781	(2)	
62.00	85.00	7.00	R-02	38589	(8)	
62.00	85.00	7.00	R-02	53781	(1)	
62.00	85.00	8.00	R-02	14859	(1)	
62.00	85.00	10.00	R-02	47232	(1)	00460BRG
62.00	85.00	10.00	R-02	54284	(2)	00460BRGF
62.00	85.00	10.00	R-05	14414	(1)	00460BR
62.00	85.00	11.50	A-05	38588	(8)	
62.00	85.00	11.90	B-02	14418	(1)	00805BGO
62.00	85.00	13.00	A-05	14419	(1)	
62.00	85.00	13.00	R-05	14869	(1)	00044BR
62.00	90.00	12.00	R-02	48956	(1)	
62.00	90.00	13.00	B-05	14427	(1)	
62.00	90.00	13.00	R-02	47389	(1)	
62.00	92.00	9.50	A-04	19834	(1)	00065GA
62.00	92.00	10.00	A-05	56735	(1)	
62.00	100.05	17.00	A-05	14431	(1)	01425BA
63.00	75.00	5.00	R-05	14435	(1)	
63.00	78.00	8.00	R-05	54459	(1)	
63.00	80.00	8.00	A-05	10780	(1)	
63.00	81.00	10.00	A-05	14459	(1)	01408BA
63.00	85.00	10.00	B-05	14440	(1)	
63.00	85.00	13.00	R-02	14439	(1)	
63.00	90.00	10.00	R-05	39044	(2)	
63.00	90.00	12.00	B-05	14443	(1)	
63.00	92.00	10.00	A-02	56665	(1)	
63.00	92.00	10.00	B-05	14445	(1)	
63.10	98.10	8.00	R-02	56639	(2)	
63.50	76.10	9.50	R-05	19840	(1)	00907BR
63.50	76.20	6.40	A-04	19841	(1)	01870GA
63.50	76.20	6.40	R-04	81761	(1)	
63.50	80.17	7.94	R-05	14453	(1)	
63.50	82.50	12.70	B-05	14460	(1)	01790B
63.50	82.55	11.11	R-02	56730	(2)	
63.50	82.55	12.70	A-02	40314	(5)	02504BAGP
63.50	82.55	12.70	A-02	39046	(2)	02478BAGF
63.50	85.55	12.70	A-02	14465	(1)	01541BAG
63.50	85.73	12.70	R-05	14468	(1)	
63.50	88.90	9.52	R-02	14476	(1)	
63.50	88.90	11.00	R-02	39047	(2)	02498BRGF
63.50	88.90	12.70	A-02	14478	(1)	00120BAG
63.50	88.90	12.70	A-02	38591	(8)	
63.50	88.90	12.70	A-05	14480	(1)	01863BA

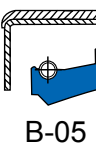
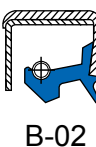

Eixo	Aloj.	Alt.	Modelo	Código CBV	T. M.	Conversão
63.50	88.90	12.70	R-02	14479	(1)	
63.50	88.90	13.49	A-02	14484	(1)	
63.50	88.90	17.80	B-02	14487	(1)	00652BG
63.50	89.90	12.00	B-05	14491	(1)	00378B
63.50	90.00	9.50	A-05	53860	(1)	
63.50	90.09	11.91	R-02	14493	(1)	
63.50	90.09	12.70	B-05	14498	(1)	
63.50	92.08	9.53	A-02	56666	(1)	
63.50	92.08	11.91	B-02	14503	(1)	
63.50	92.10	9.50	R-02	56526	(1)	
63.50	95.25	7.94	R-05	14508	(1)	
63.50	110.00	13.00	B-05	14591	(1)	01462B
63.60	88.90	13.50	A-02	14522	(1)	02256BAG
63.90	73.00	3.20	A-04	40340	(1)	02255GA
64.00	80.00	8.00	A-02	40315	(5)	02004BAGP
64.00	80.00	8.00	A-05	14523	(1)	
64.00	80.00	10.00	R-05	55717	(2)	
64.00	80.00	13.00	B-05	14526	(1)	
64.00	90.00	10.00	B-05	39045	(1)	
64.00	90.00	10.00	R-02	38592	(8)	02399BRGS
64.00	90.00	13.00	A-02	14531	(1)	
64.70	88.60	13.00	R-02	56186	(2)	
65.00	75.00	8.00	A-04	19860	(1)	
65.00	75.00	9.00	R-02	14541	(1)	
65.00	80.00	7.50	R-02	56638	(2)	
65.00	80.00	8.00	A-05	53861	(1)	
65.00	80.00	8.00	B-05	39159	(2)	
65.00	80.00	8.00	R-02	47250	(1)	
65.00	80.00	8.00	R-05	14542	(1)	01160BR
65.00	80.00	8.00	R-05	39155	(2)	
65.00	80.00	10.00	R-02	57330	(1)	
65.00	80.00	10.00	R-05	38593	(8)	
65.00	85.00	10.00	A-05	39049	(2)	
65.00	85.00	10.00	B-5B	14546	(1)	
65.00	85.00	10.00	R-02	50379	(1)	02530BRG
65.00	85.00	10.00	R-05	14547	(1)	00926BR
65.00	85.00	10.00	R-05	39048	(2)	
65.00	85.00	12.00	A-02	39050	(2)	
65.00	85.00	12.00	A-02	54663	(1)	
65.00	85.00	12.00	B-05	55836	(1)	
65.00	85.00	12.00	R-02	14550	(1)	
65.00	85.00	12.00	R-05	14552	(1)	
65.00	85.00	12.00	R-05	51255	(2)	
65.00	85.00	13.00	R-05	14554	(1)	
65.00	85.10	10.00	A-02	14545	(1)	
65.00	88.00	12.00	R-05	14561	(1)	
65.00	88.30	12.70	B-02	14597	(1)	01454BGO
65.00	88.45	12.70	A-05	14560	(1)	00903BA
65.00	90.00	7.50	R-02	55744	(1)	
65.00	90.00	10.00	A-02	14563	(1)	
65.00	90.00	10.00	A-05	14564	(1)	
65.00	90.00	10.00	A-05	56613	(2)	
65.00	90.00	10.00	B-05	14565	(1)	
65.00	90.00	10.00	R-02	14566	(1)	00051BRG
65.00	90.00	10.00	R-05	14567	(1)	00051BR
65.00	90.00	12.00	B-05	14568	(1)	00164BAG

T. M. = Tipo de Material

(1) 70 NBR (2) 70 FPM (3) 80 NBR (4) 80 FPM (5) 70 ACM (6) 70 CR (7) 63 PG (8) 70 VMQ (9) 70 EPDM (10) 90 PU

Eixo	Aloj.	Alt.	Modelo	Código CBV	T. M.	Conversão
65.00	90.00	12.00	R-05	14569	(1)	
65.00	90.00	13.00	A-02	14574	(1)	00164BAG
65.00	90.00	13.00	R-02	14572	(1)	
65.00	90.00	13.00	R-05	14573	(1)	00164BR
65.00	90.00	15.00	A-02	38595	(8)	01810BAGS
65.00	90.00	15.00	A-05	14576	(1)	
65.00	90.00	15.00	A-05	38596	(8)	
65.00	90.20	14.60	A-05	14580	(1)	
65.00	90.25	10.00	R-05	56664	(5)	00051BRP
65.00	92.00	17.80	B-02	14605	(1)	01489BGO
65.00	95.00	10.00	R-02	46919	(1)	
65.00	95.00	10.00	R-05	14579	(1)	
65.00	95.00	13.00	B-05	14582	(1)	
65.00	95.00	13.00	R-05	53784	(1)	
65.00	100.00	10.00	A-05	14583	(1)	
65.00	100.00	10.00	R-02	52080	(1)	
65.00	100.00	10.00	R-02	54703	(2)	
65.00	100.00	10.00	R-05	14584	(1)	
65.00	100.00	10.00	R-07	47272	(1)	
65.00	100.00	13.00	A-02	14588	(1)	
65.00	100.00	13.00	R-05	14589	(1)	02113BR
65.09	88.90	12.70	B-05	14601	(1)	
65.09	88.90	12.70	R-02	14600	(1)	
65.30	79.40	6.50	A-04	57200	10	
65.80	88.40	12.70	A-05	14610	(1)	00058BA
65.80	88.40	12.70	B-05	14612	(1)	00058B
66.00	82.50	10.00	R-02	54586	(1)	
66.00	92.20	9.50	A-05	38381	(6)	
66.00	92.20	9.50	A-05	38597	(8)	
66.68	85.73	9.92	R-05	14626	(1)	
66.68	88.90	9.53	R-05	14629	(1)	
66.68	90.09	11.91	R-05	14635	(1)	
66.68	95.25	7.00	R-02	14642	(1)	
66.68	95.25	10.70	B-05	54775	(1)	
66.68	97.00	12.70	A-05	56313	(1)	
66.70	85.60	12.00	B-02	40337	(5)	02272BGP
66.70	88.35	12.70	B-05	14614	(1)	00651B
66.70	88.90	12.70	R-05	14634	(1)	00369BR
66.70	92.00	11.00	B-02	40338	(5)	02271BGP
66.70	92.00	12.00	B-05	14638	(1)	00030B
66.70	95.25	12.70	R-05	14643	(1)	00379BR
66.70	112.65	11.00	B-05	14654	(1)	00434B
67.00	80.00	10.00	A-05	14653	(1)	
67.00	80.00	10.00	R-02	14655	(1)	
67.00	85.00	10.00	B-05	14657	(1)	
68.00	80.00	10.00	A-02	14665	(1)	
68.00	84.00	7.00	R-05	14664	(1)	
68.00	85.00	10.00	A-05	39053	(2)	02556BAF
68.00	85.00	10.00	R-02	14695	(1)	02557BRG
68.00	90.00	10.00	A-02	14645	(1)	00228BAG
68.00	90.00	10.00	A-05	39055	(2)	02292BAF
68.00	90.00	10.00	R-02	14673	(1)	02445BRG
68.00	90.00	10.00	R-05	14676	(1)	02445BR
68.00	90.00	10.00	R-05	39054	(2)	
68.00	90.00	12.00	B-05	14678	(1)	
68.00	90.00	13.00	A-02	14228	(5)	00500BAGP

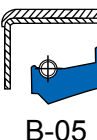
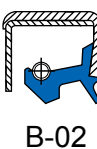

Eixo	Aloj.	Alt.	Modelo	Código CBV	T. M.	Conversão
68.00	90.00	13.00	A-02	14679	(1)	00500BAG
68.00	90.00	13.00	A-02	39051	(2)	00500BAGF
68.00	90.00	13.00	R-05	54125	(1)	
68.00	95.00	12.00	R-02	53638	(1)	
68.00	95.00	13.00	B-05	14687	(1)	
68.00	98.00	10.00	R-02	51381	(1)	
68.00	100.00	10.00	R-05	14690	(1)	
68.00	100.00	12.00	B-05	14692	(1)	
68.00	100.00	12.00	R-05	55394	(1)	
68.00	100.00	12.00	R-05	54434	(2)	
68.00	100.00	13.00	B-05	54126	(1)	
68.26	85.73	9.53	R-02	14696	(1)	
69.00	90.00	10.00	R-05	14708	(1)	
69.00	90.00	13.00	R-02	38602	(8)	
69.00	125.00	12.00	R-02	14710	(1)	
69.80	90.00	8.00	R-05	40316	(5)	02422BRP
69.80	90.00	10.00	A-02	14724	(1)	02423BAG
69.80	92.00	11.00	R-02	39056	(2)	02499BRGF
69.80	92.00	14.20	R-02	14738	(1)	00891BRG
69.80	95.20	12.70	B-05	14739	(1)	00376B
69.80	95.25	16.00	B-02	14741	(1)	01865BGO
69.80	98.45	11.80	A-05	14742	(1)	
69.80	98.45	11.90	A-02	14744	(1)	01880BAG
69.80	98.75	12.70	R-05	14747	(1)	
69.85	88.90	12.70	A-05	14721	(1)	02085BA
69.85	95.25	9.53	A-02	14734	(1)	
69.85	95.25	11.11	R-05	10956	(1)	
69.90	90.09	12.70	A-05	14726	(1)	
69.90	92.25	12.70	B-02	39064	(2)	02560BGF
69.90	92.25	12.70	R-05	54556	(1)	02560BR
69.90	98.45	12.70	B-05	14746	(1)	00081B
70.00	80.00	10.00	R-02	14763	(1)	
70.00	80.00	10.00	R-02	39057	(2)	
70.00	83.00	5.00	A-04	19908	(1)	
70.00	85.00	7.00	R-04	14765	(1)	02637GR
70.00	85.00	7.00	R-05	14764	(1)	
70.00	85.00	8.00	A-02	39058	(2)	02297BAGF
70.00	85.00	8.00	A-02	38598	(8)	02398BAGS
70.00	85.00	8.00	R-02	14767	(1)	02677BRG
70.00	85.00	8.00	R-05	14766	(1)	00906BR
70.00	85.00	8.00	R-05	55628	(2)	
70.00	85.00	10.00	A-05	14769	(1)	
70.00	85.00	10.00	R-02	40317	(1)	
70.00	85.00	12.00	R-05	38382	(1)	
70.00	85.10	10.00	A-02	14771	(1)	
70.00	90.00	7.00	R-02	55396	(1)	
70.00	90.00	8.00	A-02	56663	(2)	
70.00	90.00	9.00	A-05	14774	(1)	
70.00	90.00	10.00	A-05	14776	(1)	01135BA
70.00	90.00	10.00	B-05	14777	(1)	01135B
70.00	90.00	10.00	R-02	14775	(1)	01135BRG
70.00	90.00	10.00	R-02	39060	(2)	01135BRGF
70.00	90.00	10.00	R-02	38600	(8)	01135BRGS
70.00	90.00	10.00	R-02	40318	(5)	02192BRGP
70.00	90.00	10.00	R-04	19909	(1)	01135GR
70.00	90.00	10.00	R-05	14778	(1)	01135BR

T. M. = Tipo de Material

(1) 70 NBR (2) 70 FPM (3) 80 NBR (4) 80 FPM (5) 70 ACM (6) 70 CR (7) 63 PG (8) 70 VMQ (9) 70 EPDM (10) 90 PU

Eixo	Aloj.	Alt.	Modelo	Código CBV	T. M.	Conversão
70.00	90.00	10.00	R-05	38599	(5)	01135BRP
70.00	90.00	10.00	R-05	39059	(2)	01135BRF
70.00	90.00	10.00	R-5S	49362	(1)	
70.00	90.00	11.00	R-07	39149	(2)	
70.00	90.00	12.00	B-02	14779	(1)	
70.00	90.00	12.00	B-05	55395	(1)	
70.00	90.00	12.00	R-02	38601	(8)	
70.00	90.00	12.00	R-05	14781	(1)	
70.00	90.00	13.00	R-02	14784	(1)	
70.00	90.00	13.00	R-02	39061	(2)	
70.00	90.00	13.00	R-05	14787	(1)	00490BR
70.00	90.00	13.00	R-07	39150	(1)	
70.00	90.00	13.00	R-07	53776	(2)	
70.00	90.00	15.00	A-02	14788	(1)	
70.00	90.00	15.00	A-02	38603	(8)	
70.00	90.00	15.00	R-02	39063	(2)	02061BRGF
70.00	90.00	15.00	R-05	14789	(1)	
70.00	90.50	10.00	R-05	40319	(5)	01927BRP
70.00	95.00	8.00	R-02	51857	(1)	
70.00	95.00	10.00	R-02	56603	(1)	
70.00	95.00	10.00	R-05	14796	(1)	
70.00	95.00	13.00	A-05	14801	(1)	
70.00	95.00	13.00	R-02	14797	(1)	01879BRG
70.00	95.00	13.00	R-05	14798	(1)	
70.00	95.50	12.50	A-05	56734	(1)	
70.00	100.00	8.00	R-02	53996	(1)	
70.00	100.00	8.00	R-02	54544	(2)	
70.00	100.00	10.00	B-05	14805	(1)	
70.00	100.00	10.00	R-02	14808	(1)	
70.00	100.00	10.00	R-02	50995	(2)	
70.00	100.00	10.00	R-05	14806	(1)	00866BR
70.00	100.00	12.00	R-02	14810	(1)	00423BRG
70.00	100.00	12.00	R-05	14809	(1)	00423BR
70.00	100.00	13.00	R-05	14813	(1)	
70.00	105.00	13.00	A-05	14816	(1)	
70.00	110.00	8.00	R-05	14820	(1)	
70.00	110.00	10.00	R-02	14821	(1)	
70.00	110.00	12.00	B-02	53616	(1)	
70.00	110.00	12.00	R-02	48992	(1)	
70.00	110.00	13.00	B-05	14824	(1)	
70.00	110.00	13.00	R-02	56288	(2)	
70.00	110.00	13.00	R-05	14825	(1)	
70.00	115.00	15.00	A-05	14826	(1)	
70.00	120.00	12.90	B-05	14829	(1)	
70.00	125.00	12.00	R-02	14830	(1)	
71.00	85.00	8.00	R-05	14833	(1)	
71.00	88.80	9.00	A-05	14839	(1)	
71.00	88.80	9.00	A-05*	14841	(1)	
71.44	88.90	11.10	B-05	54127	(1)	
71.44	88.90	11.11	R-05	54164	(1)	
72.00	90.00	10.00	B-05	14855	(1)	
72.00	90.00	10.00	R-02	55630	(2)	
72.00	90.00	10.00	R-05	14856	(1)	
72.00	90.00	12.00	A-05	14857	(1)	
72.00	91.00	12.00	A-05	14858	(1)	
72.00	95.00	10.00	R-02	55655	(1)	

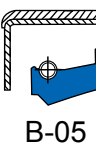
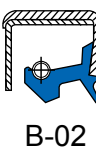

Eixo	Aloj.	Alt.	Modelo	Código CBV	T. M.	Conversão
72.00	95.00	10.00	R-05	39065	(2)	
72.00	95.00	10.00	R-05	38604	(8)	
72.00	100.00	10.00	B-05	14874	(1)	
72.00	100.00	10.00	R-05	14875	(1)	
72.00	100.00	12.00	B-05	14877	(1)	
72.00	100.00	13.00	R-05	14880	(1)	
72.00	127.00	12.00	R-02	14885	(1)	02999BRG
72.00	140.00	12.00	R-05	57220	(2)	
72.20	100.00	12.70	B-05	14879	(1)	00087B
72.24	101.65	12.70	B-2B	49358	(2)	
72.50	92.20	9.00	A-02	14892	(1)	02759BAG
73.00	89.00	9.50	A-05	14895	(1)	
73.00	95.20	9.50	A-02	56188	(2)	
73.00	95.20	12.70	B-05	14911	(1)	00098B
73.00	101.60	11.50	A-02	14924	(1)	00421BAGG
73.00	101.60	12.70	A-02	47473	(1)	00116BAG
73.00	101.60	12.70	B-05	14923	(1)	00116B
73.03	95.25	9.53	A-02	56662	(1)	
73.03	95.25	12.70	A-02	14908	(1)	
73.03	95.25	12.70	R-02	56474	(1)	
73.03	98.43	11.11	R-05	54148	(2)	
73.03	98.43	12.70	B-05	14918	(1)	
73.03	101.60	11.11	A-02	14920	(1)	
73.03	101.60	11.11	B-05	14921	(1)	
73.50	95.00	18.00	B-05	14939	(1)	
74.00	88.00	10.00	R-05	52072	(1)	
74.00	89.00	8.00	A-05	47070	(1)	
74.00	90.00	10.00	A-02	14940	(1)	01044BAG
74.00	90.00	10.00	R-05	14942	(1)	
74.00	95.00	10.00	R-05	50999	(2)	
74.00	99.00	12.70	R-05	14949	(1)	
74.00	114.00	11.00	B-05	14955	(1)	00573B
74.60	101.60	17.40	B-02	14968	(1)	00323BGO
74.61	88.90	7.94	R-05	14959	(1)	
74.61	92.08	9.53	B-02	14961	(1)	
74.61	101.60	11.91	B-05	14967	(1)	
74.61	104.78	6.35	A-04	56199	(1)	
74.90	100.00	13.00	A-05	15013	(1)	01687BA
75.00	89.00	8.00	R-05	14979	(1)	
75.00	90.00	8.00	R-02	56660	(2)	
75.00	90.00	8.00	R-05	14978	(1)	
75.00	90.00	8.00	R-05	50854	(2)	
75.00	90.00	10.00	R-02	14982	(1)	02451BRG
75.00	90.00	10.00	R-02	55718	(2)	
75.00	90.00	12.00	A-05	14981	(1)	00893BA
75.00	90.00	12.00	B-05	14983	(1)	
75.00	90.00	12.00	R-05	14984	(1)	
75.00	90.00	15.00	R-07	19938	(1)	
75.00	95.00	5.00	A-05	14987	(1)	01673BA
75.00	95.00	8.00	R-05	14989	(1)	
75.00	95.00	8.00	R-05	56659	(8)	
75.00	95.00	9.00	R-05	56481	(1)	
75.00	95.00	10.00	R-02	14991	(1)	02531BRG
75.00	95.00	10.00	R-05	14992	(1)	02531BR
75.00	95.00	10.00	R-05	39068	(2)	
75.00	95.00	12.00	A-05	54105	(1)	

T. M. = Tipo de Material

(1) 70 NBR (2) 70 FPM (3) 80 NBR (4) 80 FPM (5) 70 ACM (6) 70 CR (7) 63 PG (8) 70 VMQ (9) 70 EPDM (10) 90 PU

Eixo	Aloj.	Alt.	Modelo	Código CBV	T. M.	Conversão
75.00	95.00	12.00	R-05	14996	(1)	02191 BR
75.00	95.00	12.00	R-05	39069	(2)	02191 BRF
75.00	95.00	13.00	B-05	14999	(1)	
75.00	95.00	13.00	R-05	39070	(2)	
75.00	95.10	13.00	R-02	14995	(1)	02753BRG
75.00	95.10	13.00	R-05	14947	(1)	00046BR
75.00	97.00	12.00	B-02	15002	(1)	
75.00	100.00	10.00	B-05	15005	(1)	
75.00	100.00	10.00	R-02	12990	(1)	02671BRG
75.00	100.00	10.00	R-02	39071	(2)	02671BRGF
75.00	100.00	10.00	R-05	15003	(1)	00609BR
75.00	100.00	12.00	A-02	38605	(8)	00269BAGS
75.00	100.00	12.00	B-05	54128	(1)	
75.00	100.00	12.00	R-05	15008	(1)	00269BR
75.00	100.00	13.00	B-02	15012	(1)	02226BG
75.00	100.00	13.00	B-05	15014	(1)	
75.00	100.00	13.00	R-02	56215	(2)	
75.00	100.00	13.00	R-05	15015	(1)	
75.00	100.00	17.00	A-02	50828	(2)	02199BAGF
75.00	100.00	17.00	R-02	15017	(1)	
75.00	102.00	9.00	R-05	56661	(1)	
75.00	105.00	13.00	R-05	15021	(1)	01183BR
75.00	105.00	14.00	B-05	15020	(1)	
75.00	110.00	13.00	A-02	15024	(1)	
75.00	110.00	13.00	A-05	15026	(1)	
75.00	110.00	13.00	B-05	15027	(1)	
75.00	115.00	10.00	R-05	54785	(1)	
75.00	124.30	9.70	R-02	55586	(1)	
75.90	95.00	11.30	R-02	40321	(5)	01856BRGP
76.00	89.70	5.50	R-05	39072	(2)	02780BRF
76.00	95.00	10.00	A-05	15040	(1)	
76.00	95.25	8.00	R-02	56656	(1)	
76.20	88.90	6.50	A-04	57142	(1)	
76.20	95.25	9.53	A-05	15053	(1)	
76.20	95.25	9.53	R-02	15052	(1)	
76.20	95.25	9.53	R-05	15054	(1)	
76.20	95.25	9.70	R-05	38606	(8)	01852BRS
76.20	95.25	11.11	B-02	15055	(1)	
76.20	98.43	12.70	R-05	15062	(1)	
76.20	98.45	11.90	B-05	15059	(1)	01857B
76.20	101.60	9.53	A-02	39074	(2)	
76.20	101.60	9.53	A-02	56658	(1)	
76.20	101.60	9.53	A-05	15068	(1)	
76.20	101.60	9.53	R-02	56733	(1)	
76.20	101.60	11.11	B-02	50684	(1)	
76.20	101.60	11.11	R-02	15071	(1)	
76.20	101.60	12.70	A-02	15076	(1)	
76.20	101.65	11.00	B-02	40322	(5)	02127BGP
76.20	101.65	11.91	B-05	15074	(1)	00357B
76.20	101.65	12.00	A-02	47740	(1)	00357BAG
76.20	101.65	12.00	A-05	15073	(1)	00357BA
76.20	101.80	9.52	A-05	56657	(2)	
76.20	101.80	11.00	A-02	11367	(1)	
76.20	101.80	12.00	R-05	57193	(2)	
76.20	101.80	15.00	B-02	15070	(1)	
76.20	101.80	15.00	B-05	15069	(1)	

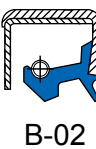

Eixo	Aloj.	Alt.	Modelo	Código CBV	T. M.	Conversão
76.20	114.30	22.23	B-07	19959	(1)	
77.00	95.00	10.00	B-05	15101	(1)	
78.00	95.00	13.00	R-05	15119	(1)	
78.00	100.00	10.00	R-02	15122	(1)	
78.00	100.00	10.00	R-05	15121	(1)	
78.00	100.00	13.00	R-02	38607	(8)	01917BRGS
78.00	100.00	13.00	R-05	50702	(1)	
78.00	110.00	13.00	A-05	54008	(1)	
78.00	110.00	13.00	R-02	15132	(1)	
78.00	110.00	13.00	R-05	15134	(1)	00819BR
79.00	100.00	10.00	B-05	39151	(2)	
79.00	100.00	10.00	R-02	15138	(1)	
79.00	111.55	10.70	A-05	15168	(1)	01301BA
79.00	121.00	16.00	B-05	15141	(1)	
79.37	104.77	9.52	R-02	56655	(1)	
79.38	100.01	11.11	R-05	15143	(1)	
79.38	101.60	12.70	R-05	15147	(1)	
79.38	104.78	12.70	B-02	15152	(1)	
79.38	104.78	14.29	B-05	15158	(1)	
79.38	107.95	15.88	B-05	15163	(1)	
79.40	104.65	12.70	B-05	15153	(1)	00221B
79.40	109.90	13.00	B-05	15165	(1)	00466B
79.40	114.30	12.70	R-05	15172	(1)	01148BR
79.40	117.40	14.30	B-05	15185	(1)	00008B
80.00	90.00	5.00	R-04	54835	(1)	
80.00	95.00	5.00	R-04	19983	(1)	
80.00	95.00	5.00	R-05	19984	(1)	
80.00	95.00	8.00	R-05	54169	(1)	
80.00	95.00	10.00	B-05	53862	(1)	
80.00	95.00	12.00	R-05	15189	(1)	
80.00	98.00	10.00	R-02	19982	(2)	05421BRGF
80.00	100.00	7.00	R-02	15194	(1)	
80.00	100.00	10.00	A-02	40323	(5)	02664BAGP
80.00	100.00	10.00	A-02	56016	(1)	
80.00	100.00	10.00	A-02	15192	(2)	03017BAGF
80.00	100.00	10.00	A-05	15195	(1)	
80.00	100.00	10.00	B-02	19985	(1)	
80.00	100.00	10.00	B-05	56325	(1)	
80.00	100.00	10.00	B-05	56563	(2)	
80.00	100.00	10.00	R-02	15193	(1)	02661BRG
80.00	100.00	10.00	R-02	52169	(7)	02661BRG
80.00	100.00	10.00	R-02	38642	(8)	02664BRGS
80.00	100.00	10.00	R-02	48466	(2)	
80.00	100.00	10.00	R-05	15197	(1)	00610BR
80.00	100.00	10.00	R-05	39075	(2)	02664BRF
80.00	100.00	12.00	A-02	15200	(1)	
80.00	100.00	12.00	A-02	38609	(8)	02235BAG
80.00	100.00	12.00	A-05	39076	(2)	02291BAF
80.00	100.00	12.00	R-02	15198	(1)	02662BRG
80.00	100.00	12.00	R-02	57066	(2)	
80.00	100.00	13.00	A-02	15203	(1)	
80.00	100.00	13.00	A-05	15201	(1)	
80.00	100.00	13.00	B-02	15202	(1)	00504BGO
80.00	100.00	13.00	B-05	15204	(1)	
80.00	100.00	13.00	B-05	53760	(2)	
80.00	100.00	13.00	R-05	15205	(1)	

T. M. = Tipo de Material

(1) 70 NBR (2) 70 FPM (3) 80 NBR (4) 80 FPM (5) 70 ACM (6) 70 CR (7) 63 PG (8) 70 VMQ (9) 70 EPDM (10) 90 PU

Eixo	Aloj.	Alt.	Modelo	Código CBV	T. M.	Conversão
80.00	104.00	12.00	R-02	55663	(1)	
80.00	105.00	10.00	R-02	15210	(1)	
80.00	105.00	13.00	A-05	15212	(1)	
80.00	105.00	13.00	B-05	15213	(1)	
80.00	105.00	13.00	R-02	15211	(1)	
80.00	105.00	13.00	R-05	15214	(1)	
80.00	105.00	13.00	R-05	55987	(2)	
80.00	105.00	18.50	R-05	15215	(1)	
80.00	106.00	13.00	R-02	57055	(1)	
80.00	106.00	14.00	A-05	56654	(1)	
80.00	106.00	14.00	R-05	54695	(2)	
80.00	108.00	13.00	R-02	55664	(1)	
80.00	110.00	10.00	R-02	56320	(8)	
80.00	110.00	10.00	R-05	15220	(1)	
80.00	110.00	10.00	R-05	46363	(2)	
80.00	110.00	12.00	R-02	15225	(1)	
80.00	110.00	12.00	R-05	15226	(1)	00900BR
80.00	110.00	13.00	B-02	15228	(1)	
80.00	110.00	13.00	B-02	56331	(8)	
80.00	110.00	13.00	R-05	54166	(1)	
80.00	110.00	14.00	A-05	54106	(1)	
80.00	115.00	10.00	R-05	15233	(1)	
80.00	125.00	12.00	R-02	49022	(1)	
80.00	125.00	13.00	B-05	15242	(1)	
80.17	98.43	11.91	R-05	15246	(1)	
80.96	107.95	15.88	B-05	15252	(1)	
80.96	138.11	14.29	B-05	15265	(1)	
81.00	100.00	13.00	B-02	15268	(1)	
81.00	114.20	12.00	B-05	15269	(1)	00134B
81.00	117.50	14.30	B-05	15261	(1)	00002B
82.00	100.00	13.00	R-05	50703	(1)	
82.00	104.70	14.30	B-05	15283	(1)	00593B
82.00	105.00	12.00	R-02	15271	(1)	
82.00	105.00	12.00	R-02	38610	(8)	01945BRGS
82.00	105.00	12.00	R-05	15272	(1)	
82.00	105.00	13.00	A-05	15273	(1)	00480BA
82.00	108.00	9.50	R-02	56252	(1)	
82.50	107.85	11.90	B-02	15289	(1)	00644BG
82.50	107.85	11.90	B-05	15290	(1)	00644B
82.50	114.30	12.70	B-02	15304	(1)	01923BG
82.50	120.00	15.00	A-02	15313	(1)	02416BAG
82.55	104.78	9.53	B-02	56315	(1)	
82.55	107.95	9.53	A-02	15286	(1)	
82.55	107.95	9.53	A-02	56189	(2)	
82.55	107.95	9.53	R-02	50686	(2)	
82.55	107.95	12.70	B-05	15294	(1)	
82.55	110.33	6.35	A-04	20002	(1)	
82.60	107.90	14.30	B-05	15297	(1)	01195B
83.90	107.70	16.00	R-02	56271	(2)	
84.00	105.00	13.00	A-05	51361	(1)	
84.00	105.00	13.00	B-05	15326	(1)	
84.00	110.00	13.00	A-05	15328	(1)	
84.00	110.05	16.00	R-05	15329	(1)	00612BR
84.00	120.00	12.00	R-05	15394	(1)	
84.14	104.78	14.29	B-05	15330	(1)	
85.00	100.00	9.00	A-05	15346	(1)	

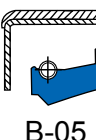
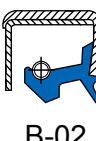

Eixo	Aloj.	Alt.	Modelo	Código CBV	T. M.	Conversão
85.00	100.00	9.50	B-05	15347	(1)	
85.00	100.00	10.00	R-05	15348	(1)	
85.00	105.00	10.00	A-05	54108	(1)	
85.00	105.00	10.00	A-05	39077	(2)	02606BAF
85.00	105.00	10.00	R-05	15356	(1)	
85.00	105.00	11.00	R-02	39079	(1)	02607BRG
85.00	105.00	12.00	R-02	15360	(1)	
85.00	105.00	12.00	R-02	39080	(2)	02283BRGF
85.00	105.00	12.00	R-02	38611	(8)	01981BRGS
85.00	105.00	12.00	R-07	54543	(2)	
85.00	105.00	13.00	B-05	15364	(1)	
85.00	105.00	13.00	R-05	15363	(1)	
85.00	105.00	13.00	R-05	54672	(2)	
85.00	108.00	8.00	R-05	15367	(1)	
85.00	110.00	8.00	R-05	55602	(2)	
85.00	110.00	10.00	B-02	52000	(1)	
85.00	110.00	12.00	B-05	15369	(1)	
85.00	110.00	12.00	R-02	15368	(1)	
85.00	110.00	12.00	R-02	15368	(1)	
85.00	110.00	12.00	R-02	39081	(2)	
85.00	110.00	12.00	R-05	15370	(1)	01767BR
85.00	110.00	13.00	B-02	15373	(1)	
85.00	110.00	13.00	R-02	15374	(1)	
85.00	110.00	13.00	R-05	15375	(1)	
85.00	110.00	14.00	A-02	15378	(1)	00618BAG
85.00	110.00	14.00	B-05	15381	(1)	
85.00	110.00	14.00	R-02	56652	(1)	
85.00	112.00	14.00	R-05	54167	(1)	
85.00	115.00	13.00	B-05	15385	(1)	
85.00	115.00	16.00	R-05	48009	(1)	
85.00	120.00	12.00	A-05	15392	(1)	
85.00	120.00	12.00	R-02	15393	(1)	
85.00	120.00	12.00	R-05	53713	(2)	
85.00	120.00	15.00	B-05	15396	(1)	
85.00	125.00	12.00	A-02	56653	(1)	
85.00	125.00	15.00	R-02	47559	(1)	
85.00	130.00	12.00	R-02	56651	(1)	
85.00	130.00	13.00	A-05	15400	(1)	
85.00	134.00	16.50	R-02	56650	(1)	
85.00	140.00	10.00	R-02	56253	(1)	
85.00	140.00	12.00	R-02	56255	(1)	
85.00	155.00	12.00	R-05	15403	(1)	
85.60	105.20	9.20	R-02	38612	(8)	
85.70	107.85	12.70	B-05	15406	(1)	02352B
85.70	114.20	11.20	R-02	15416	(1)	01912BRG
85.70	119.00	12.70	B-05	15423	(1)	00025B
85.72	114.30	14.28	B-05	54129	(1)	
85.72	120.65	13.70	A-05	50376	(1)	
85.73	114.30	12.70	B-05	15418	(1)	
85.73	120.65	12.70	B-05	15425	(1)	
85.90	100.00	11.00	R-05	38613	(8)	
85.90	104.00	11.00	R-02	39082	(2)	02264BRGF
86.00	110.00	14.00	R-02	49031	(1)	
87.00	100.00	5.00	B-05	57415	(1)	
87.00	110.00	13.00	R-05	39083	(2)	
87.30	120.80	14.30	B-05	15441	(1)	00085B

T. M. = Tipo de Material

(1) 70 NBR (2) 70 FPM (3) 80 NBR (4) 80 FPM (5) 70 ACM (6) 70 CR (7) 63 PG (8) 70 VMQ (9) 70 EPDM (10) 90 PU

Eixo	Aloj.	Alt.	Modelo	Código CBV	T. M.	Conversão
87.30	120.80	14.30	B-05	56318	(2)	
87.30	120.80	14.30	R-02	56185	(2)	
87.30	120.80	14.30	R-05	39084	(2)	
87.31	114.30	9.53	A-02	15444	(1)	
88.00	105.00	10.00	R-05	15461	(1)	
88.00	108.00	10.10	R-02	39087	(2)	05254BRGF
88.00	110.00	10.00	R-05	39085	(2)	
88.00	110.00	13.00	A-05	15464	(1)	00737BA
88.00	110.00	13.00	R-02	39086	(2)	
88.00	110.00	13.00	R-05	15465	(1)	
88.00	115.00	12.00	A-05	15467	(1)	
88.00	128.00	12.00	R-05	15471	(1)	01719BR
88.90	104.78	9.53	A-02	15473	(1)	
88.90	114.30	9.53	R-02	56217	(1)	
88.90	114.30	11.51	R-05	56649	(1)	
88.90	114.30	12.70	A-02	54095	(1)	
88.90	114.30	12.70	R-05	15495	(1)	
88.90	114.39	9.70	A-02	56645	(1)	
88.90	126.90	12.70	B-02	15519	(1)	00642BRG
88.90	126.90	12.70	B-05	47582	(1)	00642B
88.90	127.00	15.08	B-02	15520	(1)	
88.90	130.18	11.91	R-02	56644	(1)	
89.00	111.10	12.70	B-02	40324	(5)	00577BGOP
89.00	114.20	6.40	R-05	15484	(1)	01524BR
89.00	114.25	12.70	B-02	15494	(1)	02424BG
89.00	114.25	12.70	B-05	15531	(1)	01253B
89.00	114.30	11.50	B-05	15532	(1)	00300B
89.00	115.00	10.00	A-02	56234	(1)	
89.00	120.00	13.00	B-05	15533	(1)	
90.00	100.00	10.00	R-02	20248	(1)	
90.00	110.00	8.00	B-05	15540	(1)	
90.00	110.00	8.00	R-05	54168	(1)	
90.00	110.00	9.00	R-02	49036	(2)	05420BRGF
90.00	110.00	10.00	R-02	15541	(1)	
90.00	110.00	10.00	R-02	55685	(2)	
90.00	110.00	10.00	R-05	15542	(1)	
90.00	110.00	12.00	B-02	39088	(2)	
90.00	110.00	12.00	B-05	56643	(1)	
90.00	110.00	12.00	R-02	15548	(1)	02574BRG
90.00	110.00	12.00	R-02	52212	(2)	02574BRG
90.00	110.00	12.00	R-05	15545	(1)	02574BR
90.00	110.00	12.70	R-02	15547	(1)	
90.00	110.00	13.00	A-05	15550	(1)	
90.00	110.00	13.00	B-05	38383	(6)	
90.00	110.00	13.00	R-02	39090	(2)	
90.00	110.00	13.00	R-02	56642	(1)	
90.00	110.00	13.00	R-05	15549	(1)	
90.00	110.00	13.00	R-05	39089	(2)	
90.00	110.00	13.00	R-07	54116	(1)	
90.00	110.00	14.00	A-02	15552	(1)	
90.00	110.05	13.00	A-02	15529	(1)	01416BAG
90.00	110.25	13.00	R-02	56732	(2)	
90.00	112.70	13.00	B-02	39091	(2)	
90.00	112.70	13.00	B-05	15558	(1)	01829B
90.00	115.00	9.00	A-05	15560	(1)	
90.00	115.00	9.00	R-05	46364	(2)	

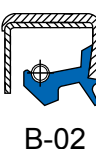

Eixo	Aloj.	Alt.	Modelo	Código CBV	T. M.	Conversão
90.00	115.00	12.00	R-05	15561	(1)	
90.00	115.00	13.00	R-02	15564	(1)	02325BRG
90.00	115.00	13.00	R-02	39092	(2)	02325BRGF
90.00	115.00	13.00	R-02	47733	(5)	02325BRGP
90.00	120.00	12.00	A-02	40325	(5)	02208BGP
90.00	120.00	12.00	R-02	15577	(1)	02751BRG
90.00	120.00	12.00	R-05	51888	(1)	
90.00	120.00	13.00	B-05	15579	(1)	
90.00	120.00	13.00	R-02	15578	(1)	00497BRG
90.00	120.00	13.00	R-02	39093	(2)	
90.00	120.00	13.00	R-05	15580	(1)	
90.00	120.00	15.00	R-02	15583	(1)	
90.00	125.00	12.00	R-05	57401	(2)	
90.00	125.00	13.00	B-05	15586	(1)	
90.00	125.00	17.00	R-05	55585	(1)	
90.00	137.00	9.00	R-05	46980	(1)	
90.00	140.00	13.00	R-05	15591	(1)	
90.10	110.00	13.00	R-05	38615	(8)	02450BRS
90.49	107.95	12.70	R-05	15593	(1)	
92.00	106.00	8.00	R-05	15615	(1)	
92.00	120.00	12.00	R-02	55631	(2)	
92.00	120.00	12.00	R-05	15620	(1)	
92.00	120.00	13.00	R-02	15621	(1)	
92.00	120.00	14.00	B-05	15623	(1)	
92.00	122.00	12.70	R-02	50727	(1)	
92.00	126.85	12.70	B-05	15624	(1)	00366B
92.08	114.30	11.91	R-02	15626	(1)	
92.08	117.48	9.53	A-05	56641	(2)	
92.08	120.65	15.88	R-02	15639	(1)	
92.08	127.00	11.91	B-05	15648	(1)	
92.10	107.70	10.00	R-02	39094	(2)	02604BRGF
92.10	123.85	21.00	B-02	15647	(1)	01251BGO
92.10	123.95	15.80	R-05	15645	(1)	00442BR
92.50	117.50	9.52	A-05	20056	(1)	
93.20	133.40	13.00	R-05	50378	(1)	
93.50	133.50	11.00	B-05	15656	(1)	
93.66	123.83	14.29	A-05	15663	(1)	
93.66	130.18	12.70	A-05	15665	(1)	
94.00	120.00	13.00	B-05	15671	(1)	
95.00	110.00	9.00	A-05	15673	(1)	
95.00	110.00	10.00	B-05	15674	(1)	
95.00	110.00	12.00	R-02	50814	(1)	
95.00	110.00	12.00	R-02	50958	(2)	
95.00	115.00	12.00	R-02	54372	(2)	
95.00	115.00	13.00	A-05	15677	(1)	
95.00	115.00	13.00	R-02	15678	(1)	02690BRG
95.00	115.00	13.00	R-02	50957	(2)	
95.00	115.00	13.00	R-05	15679	(1)	
95.00	120.00	12.00	R-02	15681	(1)	
95.00	120.00	12.00	R-02	50961	(2)	
95.00	120.00	13.00	A-02	15685	(1)	
95.00	120.00	13.00	A-05	15687	(1)	
95.00	120.00	13.00	B-05	15688	(1)	
95.00	120.00	13.00	R-02	15684	(1)	
95.00	120.80	9.50	R-05	15692	(1)	
95.00	125.00	12.00	A-05	15698	(1)	

T. M. = Tipo de Material

(1) 70 NBR (2) 70 FPM (3) 80 NBR (4) 80 FPM (5) 70 ACM (6) 70 CR (7) 63 PG (8) 70 VMQ (9) 70 EPDM (10) 90 PU

Eixo	Aloj.	Alt.	Modelo	Código CBV	T. M.	Conversão
95.00	125.00	12.00	R-05	15699	(1)	
95.00	125.00	12.00	R-2S	15696	(1)	
95.00	125.00	13.00	A-02	47424	(1)	00045BAG
95.00	125.00	13.00	A-05	15703	(1)	00045B
95.00	125.00	13.00	A-07	54788	(1)	
95.00	125.00	13.00	B-05	15701	(1)	00045B
95.00	125.00	13.00	B-05	39098	(2)	
95.00	125.00	13.00	R-02	15697	(1)	
95.00	125.00	13.00	R-02	55656	(2)	
95.00	125.00	15.00	B-05	15704	(1)	
95.00	125.00	16.00	R-05	18417	(1)	
95.00	127.00	12.50	B-05	48490	(1)	
95.00	130.00	13.00	B-05	15705	(1)	01043B
95.00	130.00	13.00	R-05	38616	(8)	
95.00	170.00	13.00	A-05	56640	(1)	
95.00	170.00	13.00	R-02	49102	(1)	
95.25	120.65	9.53	R-05	15714	(1)	
95.25	120.65	12.70	R-05	56634	(1)	
95.25	127.00	11.00	A-05	15726	(1)	
95.25	127.00	11.91	B-05	54130	(1)	
95.25	127.00	11.91	R-05	15728	(1)	
95.30	114.25	12.00	B-02	40328	(5)	02125BGP
95.30	120.55	12.70	B-05	15680	(1)	01257B
96.00	120.00	8.00	B-05	15738	(1)	
96.00	140.00	13.00	A-05	20062	(1)	
98.00	110.00	10.00	R-05	15758	(1)	
98.00	120.00	13.00	A-05	53863	(1)	
98.00	120.00	13.00	B-05	15760	(1)	
98.00	125.00	12.00	R-02	15763	(1)	
98.00	125.00	13.00	R-05	39099	(2)	
98.40	126.90	9.00	A-05	51968	(1)	
98.40	126.90	12.00	B-05	15779	(1)	02213B
98.40	127.00	12.00	R-05	15785	(1)	
98.43	124.00	13.00	B-05	15776	(1)	
98.43	130.18	13.10	R-05	15781	(1)	
98.50	144.45	19.00	B-05	15792	(1)	00007B
99.00	120.00	10.00	R-02	46354	(1)	
100.00	115.00	8.00	A-05	53864	(1)	
100.00	120.00	8.00	B-05	54131	(1)	
100.00	120.00	10.00	A-05	49807	(1)	
100.00	120.00	10.00	R-02	57149	(1)	
100.00	120.00	11.00	R-05	15806	(1)	01375BR
100.00	120.00	12.00	R-02	15807	(1)	
100.00	120.00	12.00	R-02	39100	(2)	
100.00	120.00	12.00	R-07	20243	(1)	
100.00	120.00	13.00	B-02	15811	(1)	02049BG
100.00	120.00	13.00	B-05	15810	(1)	02049B
100.00	120.00	13.00	R-02	15808	(1)	
100.00	120.00	13.00	R-05	15812	(1)	
100.00	120.00	13.00	R-05	46365	(2)	
100.00	120.00	15.00	B-05	15814	(1)	
100.00	123.80	13.00	B-02	15816	(1)	
100.00	123.80	13.00	B-05	15818	(1)	01801B
100.00	125.00	12.00	R-02	15820	(1)	
100.00	125.00	12.00	R-02	39101	(2)	
100.00	125.00	12.00	R-05	15819	(1)	01549BR

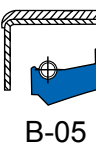
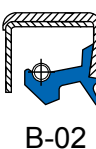

Eixo	Aloj.	Alt.	Modelo	Código CBV	T. M.	Conversão
100.00	125.00	12.00	R-05	38619	(8)	01968BRS
100.00	125.00	12.00	R-07	51330	(1)	
100.00	125.00	13.00	A-02	15823	(1)	
100.00	125.00	13.00	A-05	15826	(1)	
100.00	125.00	13.00	B-02	15825	(1)	
100.00	125.00	13.00	B-05	15824	(1)	
100.00	125.00	13.00	R-02	15822	(1)	
100.00	125.00	13.00	R-05	15827	(1)	
100.00	127.00	8.00	R-05	55500	(1)	
100.00	130.00	10.00	R-05	15832	(1)	
100.00	130.00	12.00	A-05	15834	(1)	
100.00	130.00	12.00	R-02	40329	(5)	01721BRGP
100.00	130.00	12.00	R-02	47238	(1)	
100.00	130.00	12.00	R-05	15833	(1)	01721BR
100.00	130.00	13.00	A-02	15838	(1)	00043BA
100.00	130.00	13.00	R-02	15835	(1)	01974BRG
100.00	130.00	15.00	A-05	55374	(2)	
100.00	130.00	19.00	R-05	54822	(1)	
100.00	130.25	13.00	R-05	39102	(2)	
100.00	132.00	12.00	R-02	50381	(1)	
100.00	140.00	13.00	B-02	15849	(1)	
100.00	140.00	13.00	B-05	15848	(1)	
100.00	140.00	13.00	R-05	15847	(1)	
100.00	150.00	12.00	R-05	15851	(1)	
100.00	150.00	13.00	R-02	56259	(1)	
100.00	160.00	10.00	R-05	15853	(1)	
100.00	162.10	15.00	R-05	15855	(1)	00439BR
100.01	114.30	14.29	R-05	15859	(1)	
100.01	127.00	12.70	B-02	56729	(1)	
100.01	133.35	15.87	B-05	15871	(1)	
101.00	117.00	5.50	R-04	47239	(1)	
101.00	120.00	8.00	B-05	15875	(1)	
101.00	143.30	12.70	R-05	15877	(1)	
101.60	115.89	9.53	A-05	15878	(1)	
101.60	120.65	12.70	R-02	56178	(1)	
101.60	126.90	11.20	A-05	38620	(8)	02117BAS
101.60	127.00	9.53	A-02	15885	(1)	
101.60	127.00	9.53	A-02	56192	(2)	
101.60	127.00	9.53	B-02	55790	(1)	
101.60	127.00	9.53	R-02	56214	(1)	
101.60	127.00	11.11	B-02	56244	(2)	
101.60	127.00	11.11	R-02	39103	(2)	
101.60	127.00	12.70	B-05	20219	(1)	00123B
101.60	127.00	12.70	R-05	15894	(1)	
101.60	127.00	12.70	R-05	56475	(2)	
101.60	127.00	14.00	R-05	15892	(1)	
101.60	130.05	14.30	B-05	15899	(1)	00631B
101.60	133.50	11.88	B-05	39104	(2)	
101.60	139.75	14.30	B-02	15909	(1)	01252BGO
101.60	158.75	14.29	B-05	56172	(1)	
101.80	127.20	11.90	B-02	15890	(1)	01901BGO
102.00	130.00	13.00	A-02	56728	(1)	
102.00	130.00	13.00	R-05	15922	(1)	00616BR
104.00	125.00	10.00	R-05	15940	(1)	
104.00	130.00	13.00	B-02	56272	(2)	
104.77	133.35	12.70	R-05	54288	(1)	

T. M. = Tipo de Material

(1) 70 NBR (2) 70 FPM (3) 80 NBR (4) 80 FPM (5) 70 ACM (6) 70 CR (7) 63 PG (8) 70 VMQ (9) 70 EPDM (10) 90 PU

Eixo	Aloj.	Alt.	Modelo	Código CBV	T. M.	Conversão
104.78	127.00	12.70	A-02	15943	(1)	
104.78	127.00	12.70	B-02	56726	(1)	
105.00	125.00	12.00	R-05	15965	(1)	
105.00	125.00	13.00	B-05	15966	(1)	
105.00	125.00	13.00	R-05	15964	(1)	
105.00	130.00	12.00	A-02	56564	(2)	
105.00	130.00	12.00	A-05	15969	(1)	
105.00	130.00	12.00	R-02	15968	(1)	
105.00	130.00	12.00	R-02	39105	(2)	
105.00	130.00	12.00	R-05	15970	(1)	
105.00	130.00	12.00	R-05	39106	(2)	02985BRF
105.00	130.00	13.00	A-05	54109	(1)	
105.00	130.00	13.00	B-05	15976	(1)	00491B
105.00	130.00	13.00	R-02	54604	(1)	
105.00	130.00	13.00	R-02	49597	(2)	
105.00	130.00	13.00	R-05	57046	(1)	
105.00	130.00	15.00	R-02	56739	(1)	
105.00	130.00	15.00	R-05	57045	(1)	
105.00	130.00	16.00	R-02	57044	(1)	
105.00	135.00	15.00	R-02	15981	(1)	01774BRG
105.00	135.00	15.00	R-02	56209	(2)	
105.00	140.00	12.00	A-05	15982	(1)	
105.00	140.00	12.00	B-05	15984	(1)	
105.00	140.00	12.00	R-02	55092	(1)	
105.00	140.00	12.00	R-05	15983	(1)	02195BR
105.00	140.00	13.00	A-05	15987	(1)	
105.00	140.00	13.00	B-05	15985	(1)	
105.00	140.00	15.00	B-05	15988	(1)	
105.00	142.90	12.70	A-05	15953	(1)	01268BA
105.00	145.00	15.00	A-05	15990	(1)	
106.36	133.35	11.91	B-05	16000	(1)	
106.40	126.90	12.00	B-05	15997	(1)	00650B
107.95	133.35	9.50	B-05	16049	(1)	01103B
107.95	133.35	11.91	B-02	16024	(1)	02386BG
107.95	133.35	11.91	B-05	16019	(1)	00536B
107.95	133.35	11.91	R-02	16020	(1)	
107.95	133.35	11.91	R-02	38621	(8)	
107.95	133.35	12.70	R-02	39109	(2)	
108.00	133.50	14.30	R-05	11321	(1)	
108.00	136.50	12.70	B-05	16047	(1)	01468B
108.00	140.00	14.00	B-05	16052	(1)	
108.20	144.45	19.00	B-05	16036	(1)	02021B
109.50	146.05	14.29	B-05	54132	(1)	
109.54	136.53	12.70	B-05	16054	(1)	
109.54	139.70	14.29	B-05	16058	(1)	
110.00	120.00	7.00	R-05	47278	(1)	
110.00	125.00	7.00	A-02	53959	(2)	
110.00	125.00	8.00	A-02	49355	(1)	
110.00	128.00	9.00	B-05	16072	(1)	
110.00	130.00	9.00	A-05	16074	(1)	
110.00	130.00	12.00	R-02	39111	(2)	
110.00	130.00	12.00	R-02	50691	(1)	
110.00	130.00	12.00	R-05	39110	(2)	
110.00	130.00	12.00	R-05	56876	(1)	
110.00	130.00	13.00	A-02	16077	(1)	00803BAG
110.00	130.00	13.00	A-05	16079	(1)	00803BA

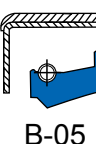
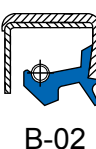

Eixo	Aloj.	Alt.	Modelo	Código CBV	T. M.	Conversão
110.00	130.00	13.00	A-05	38623	(8)	00803BAS
110.00	130.00	13.00	B-05	16081	(1)	00803B
110.00	130.00	13.00	R-02	16078	(1)	00803BRG
110.00	130.00	13.00	R-02	38622	(8)	00803BRGS
110.00	130.00	13.00	R-02	50827	(2)	00803BRGF
110.00	130.00	13.00	R-07	20098	(1)	
110.00	133.00	11.00	R-05	16083	(1)	
110.00	135.00	10.00	B-05	16084	(1)	
110.00	140.00	13.00	A-02	56725	(1)	
110.00	140.00	13.00	A-07	55532	(1)	
110.00	140.00	13.00	B-02	16091	(1)	00516BG
110.00	140.00	13.00	R-02	56847	(1)	
110.00	140.00	13.00	R-02	56228	(2)	
110.00	140.00	13.00	R-05	16092	(1)	
110.00	140.00	14.00	R-02	16087	(1)	02832BRG
110.00	140.00	15.00	B-05	54603	(1)	
110.00	140.00	15.00	R-07	55605	(2)	
110.00	140.00	16.00	R-02	55398	(2)	
110.00	145.00	15.00	A-05	16100	(1)	
110.00	146.00	14.00	B-02	47647	(1)	
110.00	146.00	14.00	R-05	38624	(1)	
110.00	150.00	12.00	R-05	49129	(1)	
110.00	150.00	13.00	B-05	16104	(1)	
110.00	160.00	12.00	R-05	16107	(1)	
110.00	160.35	12.00	R-02	50816	(1)	
110.00	180.00	15.00	R-05	16108	(1)	01427BR
110.30	133.30	12.00	B-05	16080	(1)	01739B
111.13	136.53	12.70	R-05	53683	(1)	
112.00	125.00	9.00	R-05	55702	(1)	
112.00	130.00	12.00	A-05	16125	(1)	
112.00	137.00	11.00	A-02	56014	(2)	
112.00	137.00	11.00	R-02	55168	(2)	
112.00	137.00	11.00	R-05	54702	(2)	
112.00	140.00	13.00	A-05	16128	(1)	
112.00	140.00	13.00	R-05	16127	(1)	
114.00	139.70	9.50	A-02	56190	(2)	
114.00	140.00	13.00	A-02	56278	(2)	
114.00	140.00	13.00	B-05	16144	(1)	
114.30	133.35	9.53	R-05	54448	(1)	
114.30	133.35	11.11	R-05	16149	(1)	
114.30	139.65	12.70	B-05	16157	(1)	02214B
114.30	139.65	14.30	B-05	16159	(1)	00125B
114.30	139.70	9.53	A-02	56724	(1)	
114.30	139.70	9.53	R-02	56723	(1)	
114.30	146.10	10.00	R-02	56309	(2)	
114.30	152.40	12.70	B-05	16166	(1)	01412B
114.30	155.55	14.00	B-02	16170	(1)	02180BG
114.30	158.80	15.00	B-02	56239	(8)	
115.00	130.00	9.50	R-02	54869	(2)	
115.00	130.00	13.00	A-05	16177	(1)	
115.00	135.00	13.00	A-05	16180	(1)	
115.00	135.00	13.00	R-02	56267	(2)	
115.00	135.00	13.00	R-05	56203	(1)	
115.00	140.00	9.80	R-02	20222	(1)	
115.00	140.00	12.00	R-02	38625	(8)	
115.00	140.00	12.00	R-02	54146	(1)	

T. M. = Tipo de Material

(1) 70 NBR (2) 70 FPM (3) 80 NBR (4) 80 FPM (5) 70 ACM (6) 70 CR (7) 63 PG (8) 70 VMQ (9) 70 EPDM (10) 90 PU

Eixo	Aloj.	Alt.	Modelo	Código CBV	T. M.	Conversão
115.00	140.00	12.00	R-05	16183	(1)	
115.00	140.00	12.00	R-05	39112	(2)	
115.00	140.00	13.00	A-05	52075	(1)	
115.00	140.00	13.00	B-05	16187	(1)	
115.00	140.00	13.00	R-05	16185	(1)	00514BR
115.00	140.00	13.00	R-05	51128	(8)	00514BRS
115.00	140.00	14.00	R-05	16189	(1)	
115.00	150.00	12.00	R-05	16200	(1)	
115.00	150.00	13.00	B-05	16201	(1)	
115.00	150.00	13.00	R-05	16202	(1)	
115.88	158.75	14.28	B-05	16215	(1)	
115.89	146.05	14.29	R-05	16211	(1)	
116.00	140.00	13.00	R-02	52084	(1)	
117.00	150.00	13.00	B-05	16222	(1)	
117.08	146.05	14.49	B-05	16224	(1)	
117.40	142.87	12.50	R-05	20110	(2)	07461BRF
117.40	142.87	12.70	R-05	16220	(1)	
117.47	142.87	12.70	R-02	56731	(1)	
117.48	142.88	12.70	R-02	56187	(2)	
117.48	149.23	15.88	B-05	16225	(1)	
117.48	158.75	14.29	B-05	16228	(1)	
117.50	146.00	14.30	B-02	16223	(1)	02092BGO
118.00	140.00	10.00	R-05	47023	(1)	
118.00	140.00	13.00	B-05	16231	(1)	01770B
118.00	150.00	12.00	R-02	16230	(1)	
118.00	150.00	12.00	R-02	55684	(2)	
118.00	150.00	12.00	R-05	50696	(1)	
118.27	140.10	13.10	R-02	16233	(1)	
118.27	150.02	15.08	A-05	16235	(1)	
119.00	146.00	14.30	B-02	16239	(1)	
119.00	146.00	14.30	B-05	16240	(1)	00099B
119.00	150.00	12.00	R-02	16287	(1)	
119.00	162.10	15.00	R-05	16286	(1)	00546BR
120.00	135.00	7.00	R-02	54031	(2)	
120.00	135.00	10.00	R-07	54468	(1)	
120.00	135.00	12.00	R-05	16247	(1)	
120.00	140.00	10.00	A-05	53865	(1)	
120.00	140.00	10.00	R-2S	49138	(1)	
120.00	140.00	12.00	B-05	54133	(1)	
120.00	140.00	12.00	R-05	16251	(1)	
120.00	140.00	13.00	A-05	40331	(5)	00688BAP
120.00	140.00	13.00	B-05	54012	(1)	
120.00	140.00	13.00	R-02	57361	(2)	
120.00	140.00	13.00	R-05	16253	(1)	
120.00	140.15	13.00	A-02	47459	(5)	01885BAGP
120.00	140.15	13.00	A-02	46881	(2)	01885BAGF
120.00	140.15	13.00	A-02	38626	(8)	01885BAGS
120.00	140.15	13.00	A-05	47609	(1)	01885BAG
120.00	144.95	15.00	B-02	16256	(1)	01884BG
120.00	144.95	15.00	B-05	16255	(1)	01884B
120.00	145.00	15.00	R-05	54170	(1)	
120.00	150.00	12.00	R-02	16263	(1)	
120.00	150.00	12.00	R-02	56568	(2)	
120.00	150.00	12.00	R-05	39114	(2)	
120.00	150.00	12.00	R-05	56721	(1)	
120.00	150.00	13.00	A-02	56719	(1)	

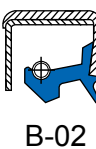

Eixo	Aloj.	Alt.	Modelo	Código CBV	T. M.	Conversão
120.00	150.00	13.00	A-05	16272	(1)	
120.00	150.00	13.00	R-02	16264	(1)	
120.00	150.00	15.00	B-05	16277	(1)	
120.00	150.00	15.00	R-02	16273	(1)	
120.00	150.00	15.00	R-02	55662	(2)	
120.00	155.00	10.00	B-05	16280	(1)	
120.00	155.00	15.00	R-02	56297	(1)	
120.00	160.00	12.00	R-05	16285	(1)	
120.00	160.00	13.00	B-05	16288	(1)	
120.00	160.00	15.00	A-05	38384	(6)	
120.65	152.40	15.88	R-05	54165	(1)	
120.65	168.28	15.88	A-05	56760	(1)	
120.70	146.05	12.50	A-02	13101	(5)	00250BRP
120.70	146.05	12.50	R-05	16296	(1)	00250BR
122.20	140.80	11.80	R-02	38627	(8)	02115BRG
122.20	140.80	12.00	R-02	39115	(2)	02449BRGF
122.20	146.05	14.29	B-05	16331	(1)	
123.00	152.50	13.00	R-02	39116	(2)	
123.84	152.40	12.70	B-05	38385	(6)	
125.00	140.00	13.00	B-05	16356	(1)	
125.00	149.95	15.00	B-05	16370	(1)	
125.00	150.00	12.00	R-02	16363	(1)	
125.00	150.00	12.00	R-05	16360	(1)	
125.00	150.00	12.00	R-05	57324	(2)	
125.00	150.00	13.00	A-02	49704	(1)	
125.00	150.00	13.00	A-02	39117	(2)	
125.00	150.00	13.00	A-02	49704	(1)	
125.00	150.00	13.00	R-02	16361	(1)	02868BRG
125.00	150.00	15.00	A-02	39119	(2)	02156BAGF
125.00	150.00	15.00	A-05	16371	(1)	
125.00	150.00	15.00	B-02	16368	(1)	01735BG
125.00	150.00	15.00	B-05	49149	(1)	
125.00	150.00	16.00	R-02	53995	(1)	
125.00	150.00	16.00	R-02	50894	(2)	
125.00	150.10	13.00	R-05	16365	(1)	00420BR
125.00	150.25	13.00	R-05	39118	(2)	
125.00	155.00	14.00	R-05	16375	(1)	
125.00	160.00	12.00	A-05	16381	(1)	
125.00	160.00	12.00	R-05	16379	(1)	00780BR
125.00	160.00	12.00	R-05	56179	(2)	
125.00	160.00	15.00	B-05	16383	(1)	
125.41	152.40	14.29	B-05	16392	(1)	
125.41	158.75	13.10	A-02	16394	(1)	
127.00	148.00	9.50	R-02	39120	(2)	
127.00	152.00	8.00	R-05	51860	(1)	
127.00	152.40	12.70	A-05	54182	(1)	
127.00	152.40	12.70	R-02	16403	(1)	
127.00	158.70	12.70	B-05	16412	(1)	00309B
127.00	158.72	12.70	R-02	56213	(1)	
127.00	158.72	12.70	R-02	56268	(2)	
127.00	165.10	16.00	B-02	16424	(1)	00310BG
127.00	165.10	16.00	B-05	16423	(1)	00310B
127.00	168.28	14.29	A-02	16426	(1)	
128.00	150.00	13.00	B-05	16436	(1)	
128.00	150.00	13.00	R-05	16437	(1)	
128.00	150.00	15.00	B-05	16439	(1)	

T. M. = Tipo de Material

(1) 70 NBR (2) 70 FPM (3) 80 NBR (4) 80 FPM (5) 70 ACM (6) 70 CR (7) 63 PG (8) 70 VMQ (9) 70 EPDM (10) 90 PU

Eixo	Aloj.	Alt.	Modelo	Código CBV	T. M.	Conversão
128.00	150.00	15.00	R-05	16440	(1)	
128.00	160.00	15.00	B-05	16442	(1)	
128.59	155.58	12.70	B-05	16443	(1)	
128.59	155.58	12.70	R-02	54001	(9)	
129.00	149.00	10.00	R-02	51290	(1)	
129.00	160.00	15.00	B-05	16455	(1)	
130.00	145.00	10.00	R-05	55588	(1)	
130.00	150.00	15.00	R-02	39121	(2)	
130.00	155.00	10.50	B-02	16458	(1)	
130.00	155.00	10.50	B-05	16459	(1)	
130.00	160.00	12.00	A-02	16467	(1)	
130.00	160.00	12.00	A-02	56175	(2)	
130.00	160.00	12.00	R-02	16466	(1)	
130.00	160.00	12.00	R-02	38629	(8)	
130.00	160.00	12.00	R-02	50959	(2)	
130.00	160.00	12.00	R-05	16462	(1)	01193BR
130.00	160.00	13.00	A-05	40333	(5)	01822BAP
130.00	160.00	13.00	R-05	16468	(2)	
130.00	160.00	14.00	B-05	54136	(1)	
130.00	160.00	14.00	R-02	16472	(1)	
130.00	160.00	15.00	B-05	16474	(1)	
130.00	160.00	15.00	B-05	39122	(2)	
130.00	160.00	15.00	R-02	38630	(8)	02069BRGS
130.00	160.15	13.00	R-02	48515	(1)	
130.00	165.00	17.00	R-05	16477	(1)	
130.00	170.00	12.00	R-05	16478	(1)	
130.00	170.00	12.00	R-05	54171	(2)	
130.00	170.00	13.00	R-02	39123	(2)	
130.00	170.00	13.00	R-02	54464	(1)	
130.00	170.00	14.00	B-05	16481	(1)	
130.00	170.00	15.00	R-05	16485	(1)	
130.00	170.00	16.00	B-05	54137	(1)	
130.00	180.00	15.00	B-05	56808	(1)	
130.18	161.85	12.70	B-05	16492	(1)	
130.18	161.93	15.88	R-02	56324	(1)	
131.76	158.75	14.29	B-02	56806	(2)	
132.00	150.00	13.00	R-05	16517	(1)	
132.00	160.00	15.00	R-02	16520	(1)	
133.00	160.00	15.00	R-02	16521	(1)	01953BRG
133.30	158.75	13.00	R-02	39152	(2)	02583BRGF
133.30	158.75	13.00	R-02	38632	(8)	01972BRGS
133.30	158.75	13.00	R-02	39152	(2)	
133.35	158.75	14.29	B-05	56804	(1)	
133.35	161.93	14.20	R-02	56210	(1)	
133.35	161.93	14.29	B-05	56227	(1)	
133.35	162.00	12.70	B-02	56803	(2)	
133.40	155.55	14.00	A-02	16524	(1)	02245BAG
133.40	165.10	15.90	B-05	16530	(1)	01362B
134.00	160.00	15.00	R-02	56241	(2)	
134.00	170.00	15.00	A-02	56182	(1)	
134.50	170.00	12.00	R-02	55512	(8)	
134.94	158.75	12.70	R-05	56463	(1)	
135.00	160.00	12.00	R-02	54836	(2)	
135.00	160.00	13.00	A-02	56802	(1)	
135.00	160.00	13.00	R-05	54172	(1)	
135.00	160.00	15.00	B-02	16562	(1)	

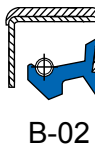

Eixo	Aloj.	Alt.	Modelo	Código CBV	T. M.	Conversão
135.00	165.00	15.00	R-05	16571	(1)	
135.00	168.00	15.00	B-02	56801	(1)	
135.00	168.00	15.00	B-05	16574	(1)	
135.00	168.00	15.00	R-02	16575	(1)	
135.00	170.00	12.00	R-02	16578	(1)	
135.00	170.00	12.00	R-02	50960	(2)	
135.00	170.00	13.00	R-05	16579	(1)	
135.00	170.00	13.00	R-05	56197	(2)	
135.00	170.00	15.00	R-05	57367	(1)	
135.00	175.00	16.00	R-05	16586	(1)	
135.00	180.00	15.00	B-05	16587	(1)	
135.00	189.95	15.00	R-05	16589	(1)	00042BR
136.50	168.25	15.90	B-02	16604	(1)	00649BGO
136.50	168.25	15.90	B-05	16605	(1)	00649B
136.53	161.93	12.70	R-05	16591	(1)	
138.00	160.00	12.00	R-05	16653	(1)	
138.00	160.00	15.00	B-05	53983	(1)	
138.00	160.00	15.00	B-05	54174	(2)	
139.70	165.10	12.70	R-02	16629	(1)	
139.70	165.10	15.88	B-05	16631	(1)	
139.70	165.27	14.27	B-02	54784	(1)	
139.70	171.45	12.70	A-02	56843	(1)	
139.70	171.45	12.70	A-02	56715	(1)	
139.70	171.45	12.70	R-02	50685	(2)	
139.70	171.45	15.88	RB-55	51937	(3)	
139.70	180.98	14.29	B-05	54778	(1)	
140.00	160.00	10.00	B-05	16651	(1)	
140.00	160.00	12.00	R-05	16654	(1)	
140.00	165.00	12.00	R-02	54853	(4)	
140.00	165.00	15.00	A-02	16662	(1)	02185BAG
140.00	165.00	15.00	A-02	50574	(4)	02185BAGF
140.00	165.00	15.00	B-05	16663	(1)	
140.00	165.00	15.00	R-07	55604	(4)	
140.00	170.00	12.00	R-02	38633	(8)	
140.00	170.00	13.00	R-02	56310	(1)	
140.00	170.00	13.00	R-02	56799	(2)	
140.00	170.00	13.00	R-05	16665	(1)	00502BR
140.00	170.00	14.00	B-05	16674	(1)	
140.00	170.00	14.00	R-05	16669	(1)	
140.00	170.00	15.00	B-02	16671	(1)	
140.00	170.00	15.00	R-02	50690	(2)	
140.00	170.00	15.00	R-05	16672	(1)	
140.00	170.00	16.00	R-05	47251	(1)	
140.00	170.20	12.70	R-02	56800	(1)	
140.00	170.35	13.00	A-05	20240	(1)	
140.00	171.50	13.00	R-02	56738	(1)	
140.00	171.70	15.88	R-05	18472	(1)	
140.00	172.00	12.00	R-02	56627	(1)	
140.00	174.50	13.00	R-02	53642	(1)	
140.00	180.00	12.00	R-05	16677	(1)	
140.00	180.00	15.00	B-05	16681	(1)	02223B
140.00	180.00	15.00	R-05	16682	(1)	
141.28	171.45	14.28	B-05	54138	(1)	
142.88	174.63	12.70	B-05	16703	(1)	
142.88	177.80	14.29	B-05	16704	(1)	
142.88	180.98	14.29	B-05	16705	(1)	

T. M. = Tipo de Material

(1) 70 NBR (2) 70 FPM (3) 80 NBR (4) 80 FPM (5) 70 ACM (6) 70 CR (7) 63 PG (8) 70 VMQ (9) 70 EPDM (10) 90 PU

Eixo	Aloj.	Alt.	Modelo	Código CBV	T. M.	Conversão
142.90	171.05	14.30	R-05	16702	(1)	00248BR
143.00	165.00	8.50	R-05	16709	(1)	
143.00	168.20	13.00	R-05	54492	(1)	
144.70	175.20	14.00	R-05	38635	(8)	
145.00	165.00	10.00	B-05	16726	(1)	
145.00	175.00	13.00	A-02	47588	(1)	02778BAG
145.00	175.00	13.00	B-05	16738	(1)	02778B
145.00	175.00	13.00	B-05	39126	(2)	02293BF
145.00	175.00	13.00	R-05	16739	(1)	
145.00	175.00	14.00	A-02	16740	(1)	
145.00	175.00	14.00	R-02	16752	(1)	02679BRG
145.00	175.00	15.00	R-05	16745	(1)	
145.00	180.00	13.00	B-05	16748	(1)	
145.00	180.00	13.00	R-05	16749	(1)	
145.00	180.00	15.00	R-05	16753	(1)	
146.00	168.25	16.00	B-05	16755	(1)	01928B
146.05	171.45	12.70	B-05	54783	(1)	
146.05	171.45	15.88	B-05	16758	(1)	
146.05	177.80	12.70	A-05	16761	(1)	
146.05	177.80	12.70	R-05	16760	(1)	
146.05	177.80	14.29	B-05	16762	(1)	
146.05	177.80	15.88	B-05	16764	(1)	
149.00	170.00	15.00	B-05	53866	(1)	
149.20	181.00	12.70	B-02	16794	(1)	00211BGO
149.23	174.63	12.70	B-05	16791	(1)	
149.90	176.00	16.00	R-05	55852	(1)	
150.00	170.00	10.00	B-05	16801	(1)	
150.00	170.00	10.00	B-05	56299	(2)	
150.00	170.00	10.00	R-07	54388	(1)	
150.00	170.00	11.00	B-02	56473	(2)	
150.00	170.00	15.00	R-05	16803	(1)	
150.00	180.00	8.00	R-02	55450	(1)	
150.00	180.00	12.00	B-05	16866	(1)	
150.00	180.00	12.00	R-02	54175	(1)	
150.00	180.00	13.00	R-05	38636	(8)	01910BRS
150.00	180.00	13.00	R-05	40334	(5)	01910BRP
150.00	180.00	15.00	A-02	39128	(2)	02932BAGF
150.00	180.00	15.00	B-02	56798	(1)	
150.00	180.00	15.00	B-05	16820	(1)	
150.00	180.00	15.00	R-02	16817	(1)	02933BRG
150.00	180.00	15.00	R-02	39127	(2)	
150.00	180.00	15.00	R-05	16821	(1)	01424BR
150.00	190.00	15.00	A-02	16825	(1)	
150.00	190.00	15.00	B-02	52821	(1)	
150.00	190.00	15.00	R-05	16823	(1)	
150.80	177.80	12.50	R-02	16830	(1)	02093BRG
152.00	181.50	14.00	R-05	16840	(1)	
152.40	171.45	11.91	A-02	16843	(1)	
152.40	177.80	12.70	B-05	54779	(1)	
152.40	184.15	12.70	B-05	39129	(8)	
152.40	190.50	12.70	A-02	56797	(1)	
152.40	190.50	12.70	B-05	16857	(1)	
152.40	190.50	12.70	R-05	16858	(1)	
152.40	190.50	14.29	B-05	54139	(1)	
152.40	190.50	14.29	B-05	39130	(2)	
152.40	193.68	14.29	B-02	56195	(1)	

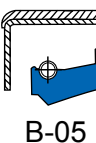
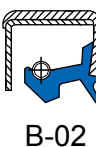

Eixo	Aloj.	Alt.	Modelo	Código CBV	T. M.	Conversão
155.00	180.00	12.00	R-05	56396	(2)	
155.00	180.00	15.00	B-05	56236	(1)	
155.00	190.00	15.00	R-05	56211	(2)	
155.57	193.67	15.87	R-05	16887	(1)	
155.58	180.98	15.88	B-05	16880	(1)	
157.16	184.15	19.05	A-02	16892	(1)	
158.00	180.00	15.00	B-05	16897	(1)	
158.00	180.00	15.00	R-05	16898	(1)	
158.75	182.56	12.70	A-02	48556	(1)	
158.75	184.15	11.11	R-05	54187	(1)	
158.75	190.50	12.70	B-05	16906	(1)	
158.75	196.85	19.05	B-05	16913	(1)	
159.70	190.30	15.00	R-05	38637	(8)	
160.00	180.00	15.00	B-05	16920	(1)	
160.00	180.00	15.00	B-05	54496	(2)	
160.00	185.00	10.00	B-05	16921	(1)	
160.00	185.00	10.00	R-02	50769	(1)	
160.00	185.00	10.00	R-05	16922	(1)	
160.00	190.00	13.00	R-02	39131	(2)	
160.00	190.00	13.00	R-02	47043	(1)	
160.00	190.00	15.00	B-05	54780	(1)	
160.00	190.00	15.00	R-02	56238	(4)	
160.00	190.00	15.00	R-02	56786	(8)	
160.00	190.00	15.00	R-05	16930	(1)	
160.00	200.00	12.00	R-05	16936	(1)	01951BR
160.00	200.00	15.00	A-02	56794	(1)	
160.00	200.00	15.00	B-02	54112	(1)	
160.00	200.00	15.00	B-05	16941	(1)	
160.00	200.00	15.00	B-05	47909	(2)	
161.90	187.30	9.50	R-05	16942	(1)	02054BR
165.00	190.00	12.90	R-02	47249	(1)	00160BRG
165.00	190.00	12.90	R-05	16963	(1)	00160BR
165.00	190.50	12.70	R-05	16961	(1)	02056BR
165.00	200.00	15.00	R-05	16969	(1)	
165.10	190.50	14.28	B-05	54140	(1)	
165.10	190.50	14.28	R-02	56858	(2)	
165.10	190.50	15.88	B-02	16979	(1)	
165.10	190.65	12.70	R-02	56296	(2)	
165.10	193.65	15.70	B-05	16982	(1)	01976B
165.10	203.20	19.05	B-05	16986	(1)	
168.00	188.00	31.50	A-02	20173	(1)	02246BAG
168.28	203.20	14.29	B-05	17000	(1)	
168.28	206.38	15.88	B-05	17002	(1)	
170.00	190.00	12.00	R-02	54452	(1)	
170.00	190.00	15.00	A-05	53581	(1)	
170.00	190.00	15.00	B-05	17009	(1)	
170.00	190.00	15.00	R-05	17010	(1)	
170.00	200.00	13.00	A-05	17012	(1)	
170.00	200.00	13.00	R-05	54189	(2)	
170.00	200.00	15.00	B-02	39132	(2)	
170.00	200.00	15.00	B-07	39153	(2)	
170.00	200.00	15.00	R-02	17015	(1)	
170.00	200.00	15.00	R-05	17018	(1)	
170.00	200.00	15.00	R-05	46373	(2)	
170.00	200.00	16.00	B-02	47292	(1)	
170.00	210.00	15.00	R-02	56237	(1)	

T. M. = Tipo de Material

(1) 70 NBR (2) 70 FPM (3) 80 NBR (4) 80 FPM (5) 70 ACM (6) 70 CR (7) 63 PG (8) 70 VMQ (9) 70 EPDM (10) 90 PU

Eixo	Aloj.	Alt.	Modelo	Código CBV	T. M.	Conversão
170.00	220.00	12.00	R-05	17029	(1)	
170.00	227.00	20.00	R-02	55525	(1)	
171.45	196.85	14.29	B-05	17031	(1)	
171.45	222.25	14.29	B-05	17046	(1)	
172.00	200.00	15.00	A-05	17048	(1)	
174.60	200.00	16.00	B-05	17065	(1)	02138B
174.63	200.03	12.70	R-05	17053	(1)	
175.00	200.00	13.00	R-02	56837	(1)	
175.00	200.00	13.00	R-05	17062	(1)	
175.00	200.00	15.00	B-02	54113	(1)	
175.00	205.00	15.00	R-05	17066	(1)	
175.00	210.00	16.00	R-02	56265	(2)	
177.00	210.00	19.50	R-05	17078	(1)	
177.00	216.00	19.05	R-05	17080	(1)	
177.50	203.30	17.00	R-07	56145	(1)	
177.80	203.20	15.88	B-05	54781	(1)	
177.80	203.20	19.05	B-05	17079	(1)	
177.80	209.55	19.05	R-05	56263	(2)	
177.80	215.90	12.70	B-02	17089	(1)	
177.80	215.90	15.88	A-02	17090	(1)	
177.80	222.25	19.05	B-05	54782	(1)	
180.00	200.00	10.00	R-05	17105	(1)	
180.00	200.00	12.00	B-05	17106	(1)	
180.00	200.00	12.00	R-04	20178	(1)	
180.00	210.00	8.00	R-05	39135	(2)	
180.00	210.00	15.00	B-05	17112	(1)	
180.00	210.00	15.00	R-02	39134	(2)	
180.00	210.00	15.00	R-05	17113	(1)	
180.00	210.00	18.00	R-02	57119	(1)	
180.00	215.00	15.00	B-02	17117	(1)	
180.00	215.00	15.00	R-02	57178	(2)	
180.00	215.00	15.00	R-07	17118	(1)	
180.00	220.00	8.00	R-05	54173	(1)	
180.00	220.00	15.00	A-05	17126	(1)	
180.00	220.00	15.00	R-05	17125	(1)	
180.00	220.00	16.00	B-05	17128	(1)	
180.00	220.00	16.00	R-05	17129	(1)	
180.00	220.00	16.00	R-07	54190	(2)	
180.00	220.00	18.00	A-05	17127	(1)	
184.15	222.25	15.88	A-02	54096	(1)	
185.00	210.00	13.00	R-05	17152	(1)	01676BR
185.00	215.00	16.00	B-05	17156	(2)	
185.00	220.00	15.00	R-02	54680	(1)	
185.00	230.00	16.00	B-05	17158	(1)	
187.33	215.90	14.29	B-05	17167	(1)	
190.00	215.00	16.00	B-05	17178	(1)	
190.00	215.00	16.00	B-05	56785	(2)	
190.00	215.00	16.00	R-05	17179	(2)	
190.00	220.00	14.80	R-02	17183	(1)	00268BRG
190.00	220.00	14.80	R-02	56301	(2)	
190.00	220.00	14.80	R-05	10453	(5)	00268BRP
190.00	220.00	14.80	R-05	17186	(1)	00268BR
190.00	220.00	15.00	A-05	54110	(1)	
190.00	220.00	15.00	B-05	54141	(1)	
190.00	220.00	16.00	R-05	54178	(1)	
190.00	225.00	12.00	R-05	17192	(1)	

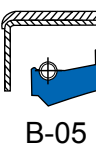
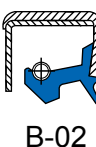

Eixo	Aloj.	Alt.	Modelo	Código CBV	T. M.	Conversão
190.00	230.00	20.00	R-02	17197	(1)	
190.50	215.90	19.05	B-05	17202	(1)	
190.50	222.25	14.29	B-05	17204	(1)	
192.00	210.00	10.00	R-02	34802	(1)	
193.68	209.55	19.05	A-05	38386	(6)	
193.68	209.55	19.05	A-07	38387	(6)	
193.68	219.08	15.88	B-05	17213	(1)	
194.00	220.00	12.00	B-02	47527	(2)	
195.00	220.00	16.00	B-05	17222	(1)	
196.40	238.40	15.70	R-05	17273	(1)	
196.85	238.13	17.46	B-05	20242	(1)	
196.85	241.30	19.05	B-05	54135	(1)	
198.50	241.00	16.50	B-05	20255	(1)	
199.50	215.00	12.70	R-05	17242	(1)	
200.00	215.00	12.70	B-02	49592	(2)	
200.00	215.00	12.70	R-05	46938	(1)	
200.00	230.00	13.00	B-05	17247	(1)	
200.00	230.00	15.00	A-05	55498	(1)	
200.00	230.00	15.00	B-05	56784	(1)	
200.00	230.00	15.00	R-02	53752	(2)	
200.00	230.00	15.00	R-05	17245	(1)	01986BR
200.00	230.00	16.00	B-05	17250	(1)	
200.00	230.00	16.00	R-02	17249	(1)	
200.00	250.00	15.00	B-05	17258	(1)	
200.00	250.00	15.00	R-02	56783	(1)	
200.00	256.00	20.00	R-02	55524	(1)	
203.20	241.30	19.05	B-05	17298	(1)	
209.55	260.35	11.11	A-04	20189	(1)	
210.00	240.00	15.00	B-02	56245	(2)	
210.00	240.00	15.00	R-02	53867	(1)	
210.00	240.00	15.00	R-02	50971	(2)	
210.00	240.00	15.00	R-05	17333	(1)	
210.00	250.00	16.00	B-05	17337	(1)	
210.00	250.00	20.00	R-02	56298	(2)	
210.00	250.00	20.00	R-05	56780	(1)	
212.00	251.00	17.00	R-07	17342	(1)	
212.73	250.83	17.46	R-05	54176	(1)	
215.00	250.00	16.00	R-05	17350	(1)	
215.90	247.65	19.05	R-02	51308	(1)	
215.90	254.00	19.05	B-05	54142	(1)	
215.90	266.70	15.88	A-02	17356	(1)	
220.00	250.00	15.00	A-02	56778	(2)	
220.00	250.00	15.00	A-05	56193	(2)	
220.00	250.00	15.00	B-02	17379	(1)	
220.00	250.00	15.00	B-02	56246	(2)	
220.00	250.00	15.00	R-05	17381	(1)	
220.00	250.00	15.00	R-05	56398	(2)	
220.00	250.00	18.00	A-02	56294	(2)	
220.00	260.00	14.00	B-05	17393	(1)	
220.00	260.00	15.00	R-02	54633	(1)	
220.00	260.00	16.00	A-05	56191	(1)	
221.00	250.00	20.00	A-05	17268	(1)	
221.40	250.00	16.00	B-05	20258	(1)	
222.00	250.00	16.00	R-05	17395	(1)	
227.00	285.00	20.00	B-05	54134	(1)	
229.00	271.00	15.00	A-05	54111	(1)	

T. M. = Tipo de Material

(1) 70 NBR (2) 70 FPM (3) 80 NBR (4) 80 FPM (5) 70 ACM (6) 70 CR (7) 63 PG (8) 70 VMQ (9) 70 EPDM (10) 90 PU

Eixo	Aloj.	Alt.	Modelo	Código CBV	T. M.	Conversão
230.00	255.00	15.00	R-02	51395	(1)	
230.00	260.00	15.00	B-02	17444	(1)	
230.00	260.00	15.00	B-05	56777	(2)	
230.00	260.00	15.00	R-02	17445	(1)	
230.00	260.00	15.00	R-05	17441	(1)	
230.00	270.00	15.00	B-02	17446	(1)	
230.00	280.00	25.00	B-05	17451	(1)	
231.78	282.58	25.40	B-02	56300	(1)	
235.00	260.00	12.70	R-05	54789	(1)	
240.00	270.00	15.00	A-02	56776	(2)	
240.00	270.00	15.00	A-05	17498	(1)	
240.00	270.00	15.00	B-02	17499	(1)	
240.00	270.00	15.00	R-05	17497	(1)	
240.00	270.00	16.00	B-05	17500	(1)	
240.00	279.00	15.00	A-05	17501	(1)	
240.00	280.00	15.00	R-02	56772	(1)	
241.30	266.70	15.88	B-05	17508	(1)	
241.30	279.40	19.05	A-05	17513	(1)	
245.00	273.50	13.00	R-04	49166	(1)	
245.00	290.00	16.00	B-02	53848	(1)	
250.00	280.00	15.00	A-05	55499	(1)	
250.00	280.00	15.00	A-05	56894	(2)	
250.00	280.00	15.00	B-05	56771	(1)	
250.00	280.00	15.00	R-02	17537	(1)	
250.00	280.00	15.00	R-05	17538	(1)	
250.00	280.00	16.00	R-05	17542	(1)	
250.00	310.00	25.00	A-05	17549	(1)	
251.00	285.00	15.00	B-05	17576	(1)	
255.00	285.00	15.00	B-05	17575	(1)	
255.00	290.00	16.00	B-05	17577	(1)	
260.00	290.00	15.00	B-05	54143	(1)	
260.00	290.00	15.00	R-05	17590	(1)	
260.00	290.00	15.00	R-05	39139	(2)	
260.00	298.10	15.87	R-05	17579	(1)	
260.00	300.00	20.00	A-07	17595	(1)	
260.00	300.00	20.00	B-02	15897	(1)	
260.00	300.00	20.00	B-02	56277	(2)	
260.00	300.00	20.00	R-02	56261	(2)	
260.00	300.00	20.00	R-05	56757	(2)	
260.00	300.00	20.00	R-07	17597	(1)	
260.00	304.00	20.00	A-05	56204	(2)	
265.00	290.00	16.00	R-05	46714	(1)	
270.00	300.00	15.00	R-05	17637	(1)	
270.00	310.00	16.00	B-05	17639	(1)	
270.00	310.00	16.00	B-05	51100	(2)	
275.00	310.00	16.00	B-05	17653	(1)	
280.00	310.00	15.00	R-05	17672	(1)	
280.00	310.00	16.00	B-05	53775	(1)	
280.00	320.00	20.00	B-02	17675	(1)	
280.00	330.00	25.00	B-05	17680	(1)	
290.00	320.00	19.00	R-02	56330	(2)	
290.00	330.00	18.00	B-05	17706	(1)	
292.10	317.50	12.70	R-05	56899	(1)	
300.00	332.00	16.00	B-05	17728	(1)	
300.00	340.00	20.00	B-05	17734	(1)	
300.00	340.00	20.00	R-02	56262	(1)	

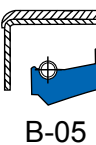
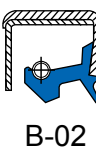

Eixo	Aloj.	Alt.	Modelo	Código CBV	T. M.	Conversão
300.00	340.00	20.00	R-02	56751	(2)	
304.80	346.08	19.05	B-05	17745	(1)	
317.50	355.60	17.46	A-02	17770	(1)	
320.00	360.00	18.00	B-05	17778	(1)	
320.00	360.00	20.00	B-02	17780	(1)	
320.00	364.00	25.00	R-05	48017	(2)	
326.30	368.00	17.60	R-02	17792	(1)	
335.00	370.00	18.00	B-02	53742	(1)	
340.00	380.00	20.00	B-02	17829	(1)	
350.00	380.00	16.00	A-05	52016	(1)	
350.00	390.00	18.00	B-02	17851	(1)	
355.00	400.00	38.00	R-07	48697	(1)	
360.00	398.00	18.00	B-02	47385	(1)	
380.00	412.00	16.00	B-05	17886	(1)	
380.00	412.00	16.00	B-05	39154	(2)	
394.00	420.00	16.00	R-05	17912	(1)	
398.00	450.00	18.00	A-05	17919	(1)	
398.00	450.00	18.00	B-05	50682	(1)	
420.00	470.00	20.00	R-05	54177	(1)	
440.00	480.00	20.00	B-05	56208	(2)	
479.50	518.00	15.00	R-02	46753	(2)	
480.00	530.00	22.00	R-05	57180	(2)	
500.00	540.00	20.00	B-05	53780	(1)	
530.00	580.00	20.00	R-02	56689	(2)	
540.00	584.00	20.00	R-05	20214	(1)	
551.00	620.00	35.00	A-07	47353	(1)	
553.00	620.00	35.00	A-07	54472	(1)	
555.00	620.00	35.00	A-07	20216	(1)	
558.50	620.00	35.00	A-07	54465	(1)	
560.00	610.00	20.00	R-02	50305	(1)	
560.00	620.00	35.00	A-07	54186	(1)	
710.00	750.00	23.00	R-05	56202	(2)	
760.00	800.00	20.00	B-05	53777	(1)	
780.00	844.00	25.00	R-05	57198	(1)	

T. M. = Tipo de Material

(1) 70 NBR (2) 70 FPM (3) 80 NBR (4) 80 FPM (5) 70 ACM (6) 70 CR (7) 63 PG (8) 70 VMQ (9) 70 EPDM (10) 90 PU

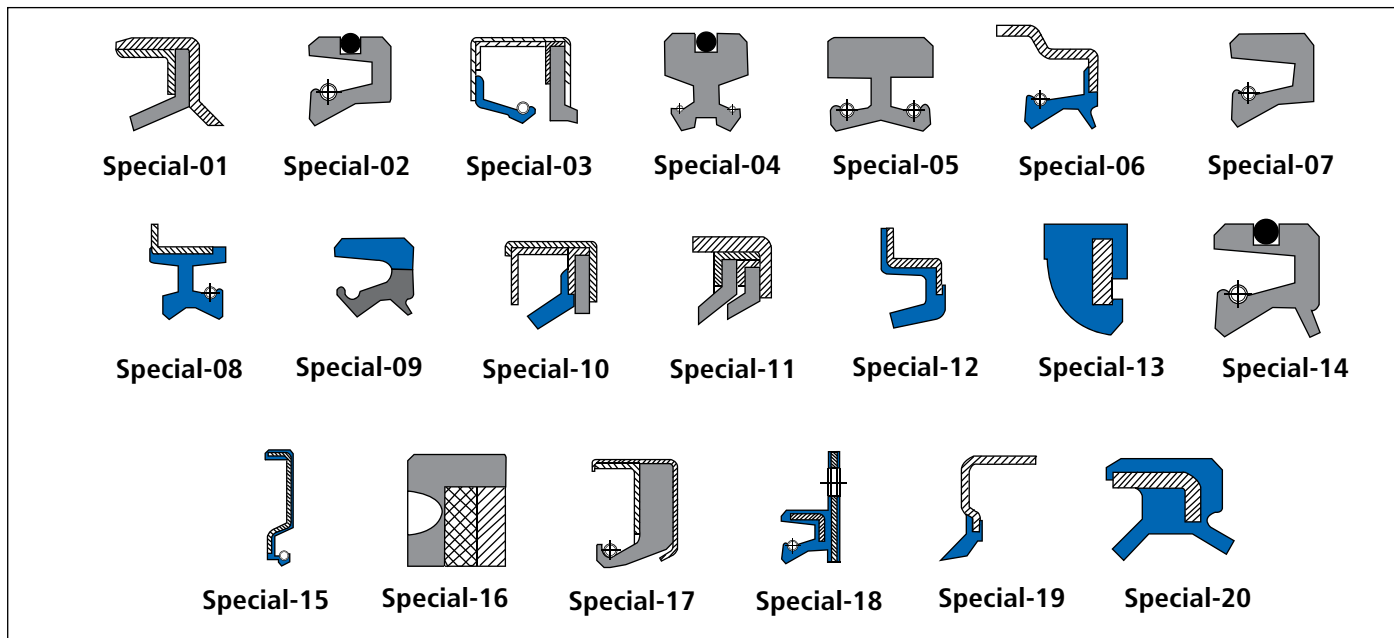

Eixo	Aloj.	Alt.		Modelo	Código CBV	T. M.	Conversão
6.00	16.00	7.00		SPECIAL-07	55667	(1)	
15.00	24.10	7.50		SPECIAL-07	49451	(1)	
20.00	47.00	12.70		SPECIAL-19	54014	(2)	01129GAE
22.00	35.00	6.50		SPECIAL-01	46964	(3)	
22.00	35.00	7.00		SPECIAL-02	42413	(1)	
24.00	43.00	7.50		SPECIAL-14	50614	(1)	
24.00	78.00	6.50		SPECIAL-15	51183	(2)	
25.00	33.00	4.00		SPECIAL-09	19003	(4)	
25.40	37.31	6.35		SPECIAL-07	54787	(1)	
25.40	38.10	11.50	9.50	SPECIAL-08	38908	(5)	
27.00	37.50	3.00		SPECIAL-10	46716	(5)	
27.00	76.00	15.00	42.00	SPECIAL-18	53769	(2)	
28.00	39.00	5.00	1.30	SPECIAL-12	49588	(2)	
29.30	43.00	12.00		SPECIAL-03	46594	(5)	
34.93	50.80	9.53		SPECIAL-11	49510	(6)	
35.00	45.00	7.00		SPECIAL-07	54192	(1)	
35.00	47.00	3.00		SPECIAL-13	38944	(5)	
35.00	46.00	4.80		SPECIAL-16	51886	(1)	
40.00	53.00	7.00		SPECIAL-01	46962	(3)	
44.50	63.50	9.50		SPECIAL-07	42407	(1)	
47.63	63.50	7.94		SPECIAL-07	54786	(1)	
55.00	69.00	7.50		SPECIAL-01	46963	(3)	
55.00	100.00	20.00		SPECIAL-04	51358	(1)	
107.00	130.00	9.00		SPECIAL-14	51283	(1)	
120.00	150.00	12.00		SPECIAL-07	51253	(1)	
158.75	182.56	24.00	12.70	SPECIAL-06	20224	(2)	
190.00	220.00	16.00		SPECIAL-05	42410	(1)	
200.00	230.00	16.00		SPECIAL-05	51360	(1)	
210.00	240.00	15.00		SPECIAL-07	48929	(1)	
315.00	355.00	18.00		SPECIAL-03	48363	(5)	
430.00	480.00	20.00		SPECIAL-17	51977	(6)	
479.50	519.30	7.00	10.00	SPECIAL-20	46862	(5)	

T. M. = Tipo de Material

(1) 57 PR (2) 70 NBR (3) 62 PFM (4) 70 PU (5) 70 FPM (6) 63 PG

Os V'rings são anéis utilizados com bastante eficiência como vedador ou raspador para sistemas rotativos, de alta velocidade e baixa pressão. Ele é fixado no eixo tendo uma grande eficiência, devido à força centrífuga que atua no mesmo, colocando para fora as partículas abrasivas, proporcionando assim, uma maior vida útil ao anel.

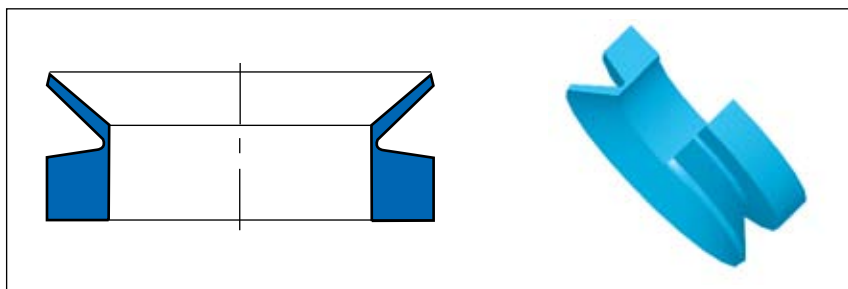

MONTAGEM:

Sua montagem no eixo é feita com uma certa pressão, e são solidários aos seus movimentos. A vedação é feita pelo lábio de vedação em uma face estacionária perpendicular ao eixo.

A face estacionária precisa estar isenta de rebarbas e partículas abrasivas para maior vida útil do anel.

MODELO DE APLICAÇÃO:





TABELA DE MODELOS:

VA-01 	VE-01 
VL-01 	VS-01 

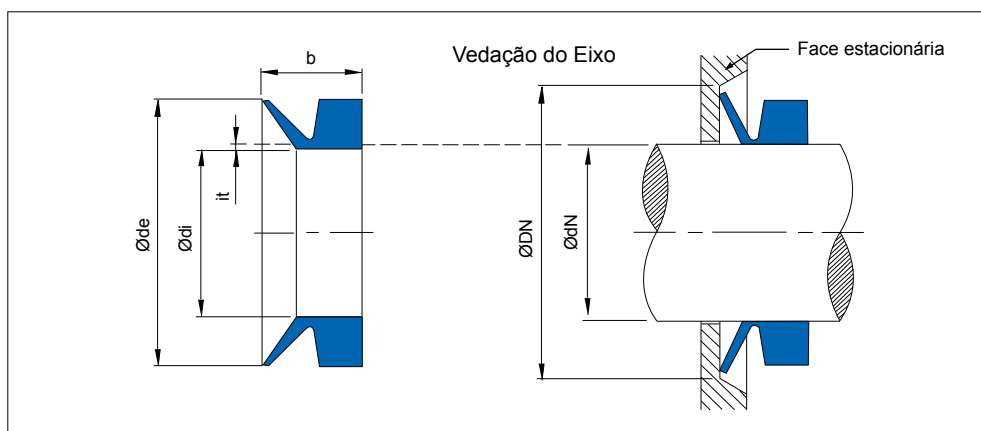
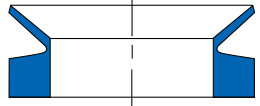
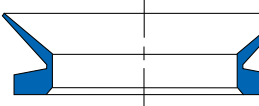

ØdN	ØDN	b	Modelo	Código CBV	T. M.	Conversão
2,50	5,50	3,00	VA-01	34960	(1)	VA-3
3,20	7,20	3,70	VA-01	34961	(1)	VA-4
4,00	8,00	3,70	VA-01	34962	(1)	VA-5
4,00	8,00	5,20	VS-01	35048	(1)	VS-5
5,00	9,00	3,70	VA-01	34963	(1)	VS-6
5,00	9,00	5,20	VS-01	35049	(1)	VS-6
6,00	10,00	3,70	VA-01	34964	(1)	VA-7
6,00	10,00	5,20	VS-01	35050	(1)	VS-7
7,00	11,00	3,70	VA-01	34965	(1)	VA-8
7,00	11,00	5,20	VS-01	35051	(1)	VS-8
9,00	15,00	5,50	VA-01	34966	(1)	VA-10
9,00	15,00	7,70	VS-01	35052	(1)	VS-10
10,50	16,50	5,50	VA-01	34967	(1)	VA-12
10,50	16,50	7,70	VS-01	35053	(1)	VS-12
12,50	18,50	5,50	VA-01	34968	(1)	VA-14
12,50	18,50	7,70	VS-01	35054	(1)	VS-14
14,00	20,00	5,50	VA-01	34969	(1)	VA-16
14,00	20,00	7,70	VS-01	35055	(1)	VS-16
16,00	22,00	5,50	VA-01	34970	(1)	VA-18
16,00	22,00	7,70	VS-01	35056	(1)	VS-18
18,00	26,00	7,50	VA-01	34971	(1)	VA-20
18,00	26,00	10,50	VS-01	35057	(1)	VS-20
20,00	28,00	7,50	VA-01	34972	(1)	VA-22
20,00	28,00	10,50	VS-01	35058	(1)	VS-22
22,00	30,00	7,50	VA-01	34973	(1)	VA-25
22,00	30,00	10,50	VA-01	34957	(1)	
22,00	30,00	10,50	VS-01	35059	(1)	VS-25
23,00	31,00	7,00	VA-01	35092	(1)	
23,00	31,00	8,00	VS-01	34956	(1)	
25,00	33,00	7,50	VA-01	34974	(1)	VA-28
25,00	33,00	10,50	VS-01	35060	(1)	VS-28
27,00	35,00	7,50	VA-01	34975	(1)	VA-30
27,00	35,00	10,50	VS-01	35061	(1)	VS-30
29,00	37,00	7,50	VA-01	34976	(1)	VA-32
29,00	37,00	10,50	VS-01	35062	(1)	VS-32
31,00	39,00	7,50	VA-01	34977	(1)	VA-35
31,00	39,00	7,50	VA-01	53878	(2)	VA-35
31,00	39,00	10,50	VS-01	35063	(1)	VS-35
34,00	42,00	7,50	VA-01	34978	(1)	VA-38
34,00	42,00	10,50	VS-01	35064	(1)	VS-38
36,00	46,00	9,00	VA-01	40017	(3)	
36,00	46,00	9,00	VA-01	34979	(1)	VA-40
36,00	46,00	13,00	VS-01	35065	(1)	VS-40
37,00	42,00	6,00	VA-01	53597	(1)	
37,50	47,50	10,50	VE-01	35088	(1)	
40,00	50,00	9,00	VA-01	34980	(1)	VA-45
40,00	50,00	9,00	VA-01	40018	(4)	
40,00	50,00	13,00	VS-01	35066	(1)	VS-45
40,00	55,00	13,00	VS-01	50189	(1)	
45,00	55,00	9,00	VA-01	34981	(1)	VA-50
45,00	55,00	13,00	VS-01	35067	(1)	VS-50
49,00	59,00	9,00	VA-01	34982	(1)	VA-55
49,00	59,00	9,00	VA-01	54309	(5)	VA-55
49,00	59,00	13,00	VS-01	35068	(1)	VS-55
54,00	64,00	9,00	VA-01	34983	(1)	VA-60
54,00	64,00	13,00	VS-01	35069	(1)	VS-60

ØdN	ØDN	b	Modelo	Código CBV	T. M.	Conversão
58,00	68,00	9,00	VA-01	34984	(1)	VA-65
58,00	68,00	13,00	VS-01	35070	(1)	VS-65
63,00	72,00	8,00	VA-01	49177	(3)	
63,00	75,00	11,00	VA-01	34985	(1)	VA-70
63,00	75,00	15,50	VS-01	35071	(1)	VS-70
67,00	79,00	11,00	VA-01	34986	(1)	VA-75
67,00	79,00	15,50	VS-01	35072	(1)	VS-75
70,00	85,00	10,00	VA-01	5089	(1)	
72,00	84,00	11,00	VA-01	4987	(1)	VA-80
72,00	84,00	11,00	VA-01	54310	(1)	VA-80
72,00	84,00	15,50	VS-01	35073	(1)	VS-80
76,00	88,00	11,00	VA-01	48665	(3)	VA-85
76,00	88,00	11,00	VA-01	34988	(1)	VA-85
76,00	88,00	15,50	VS-01	35074	(1)	VS-85
81,00	93,00	11,00	VA-01	34989	(1)	VA-90
81,00	93,00	15,50	VS-01	35075	(1)	VS-90
85,00	97,00	11,00	VA-01	34990	(1)	VA-95
85,00	97,00	15,50	VS-01	35076	(1)	VS-95
90,00	102,00	9,00	VA-01	34991	(1)	VA-100
90,00	102,00	15,50	VS-01	40021	(3)	
90,00	102,00	15,50	VS-01	35077	(1)	VS-100
99,00	113,00	10,50	VA-01	34992	(1)	VA-110
99,00	113,00	18,00	VS-01	35078	(1)	VS-110
100,00	115,00	10,00	VE-01	35091	(1)	
108,00	122,00	12,80	VA-01	34993	(1)	VA-120
108,00	122,00	18,00	VS-01	40022	(3)	VS-120
108,00	122,00	18,00	VS-01	35079	(1)	VS-120
117,00	131,00	12,80	VA-01	34994	(1)	VA-130
117,00	131,00	18,00	VS-01	35080	(1)	VS-130
120,00	135,00	12,80	VA-01	51204	(1)	
120,00	140,00	10,00	VA-01	50209	(1)	
120,00	145,00	12,80	VS-01	35029	(1)	
126,00	139,00	10,50	VL-01	53635	(3)	VL-140
126,00	139,00	10,50	VL-01	35028	(1)	VL-140
126,00	140,00	12,80	VA-01	34995	(1)	VA-140
126,00	140,00	18,00	VS-01	35081	(1)	VS-140
135,00	148,00	10,50	VL-01	35030	(1)	VL-150
135,00	149,00	12,80	VA-01	34996	(1)	VA-150
135,00	149,00	18,00	VS-01	35082	(1)	VS-150
144,00	157,00	10,50	VL-01	35031	(1)	VL-160
144,00	160,00	14,50	VA-01	34997	(1)	VA-160
144,00	160,00	20,50	VS-01	35083	(1)	VS-160
153,00	166,00	10,50	VL-01	35032	(1)	VL-170
153,00	169,00	14,50	VA-01	34998	(1)	VA-170
153,00	169,00	20,50	VS-01	35084	(1)	VS-170
160,00	174,00	10,00	VL-01	35033	(1)	
162,00	175,00	10,50	VL-01	35034	(1)	VL-180
162,00	178,00	14,50	VA-01	40019	(3)	
162,00	178,00	14,50	VA-01	4999	(1)	VA-180
162,00	178,00	20,50	VS-01	35085	(1)	VS-180
170,00	180,00	9,00	VA-01	35093	(1)	
170,00	185,00	15,00	VE-01	35090	(1)	
171,00	184,00	10,50	VL-01	35035	(1)	VL-190
171,00	187,00	14,50	VA-01	35000	(1)	VA-190
171,00	187,00	20,50	VS-01	35086	(1)	VS-190
175,00	187,00	7,00	VA-01	51167	(1)	

T. M. = Tipo de Material

(1) 60 NBR 100 (2) 60 EPD 300 (3) 60 FPM 200 (4) 70 FPM 200 (5) 80 FPM 200

O Ret. Rotary é uma vedação bidirecional composta por dois elementos: um O'ring e um anel de PTFE (carregado conforme aplicação), que tem geometria especial, a qual garante um excelente rendimento, durabilidade e eficiência. O O'ring, disponível em borracha nitrílica, viton ou outros materiais de acordo com a aplicação, garante vedação a baixas pressões.

É aplicado em eixos ou camisas de sistemas hidráulicos com movimento rotativo ou oscilante, altas pressões e baixas velocidades de deslizamento.

Dependendo do tamanho da seção transversal da vedação, a superfície de contato pode ter um ou dois canais contínuos, que tem a função de aumentar a eficiência da vedação pelo aumento de pressão sobre a superfície vedada e formar um reservatório de lubrificante para redução de atrito.

A face que suporta o O'ring tem a forma côncava. Isto aumenta a superfície de contato e evita que a vedação gire com a superfície rotativa.

VANTAGENS:

- Pode ser aplicado tanto para vedação de eixos como para camisas;
- Baixo atrito;
- Reservatório de lubrificante;
- Alojamento simples e de pequenas dimensões;
- Alta resistência à abrasão e estabilidade dimensional.

PARÂMETROS PARA OPERAÇÃO:

Pressão: Até 400 bar (40 Mpa).

Velocidade: Até 2m/s.

Temperatura de trabalho: de -40°C até 200°C (dependendo do composto do anel de borracha).

Fluidos: Óleo hidráulico mineral, fluidos hidráulicos levemente inflamáveis, bio-óleo, água e outros.

MATERIAL:

O PTFE é altamente resistente ao desgaste e graças a sua rigidez, mantém sua forma em condições de operação extrema. Assim como, resiste a praticamente todos os elementos químicos existentes, e também ao tempo e exposição à luz. Seu coeficiente de absorção de umidade é de menos de 0,01%.

MODELO DE APLICAÇÃO:



TABELA DE MODELOS:



TABELA DE TOLERÂNCIAS:

Faixa	Diâmetro do eixo ØDN (mm)		Interferência (mm)
	Maior que	Até	
A	-	25	0,00 a 0,10
C	25	50	0,10 a 0,15
D	50	100	0,20 a 0,30
E	100	200	0,30 a 0,40
G	200	300	0,40 a 0,50
H	300	500	0,50 a 0,60
I	500	750	0,70 a 0,80
J	750	1000	0,80 a 1,00
K	1000	-	1,00 a 1,20

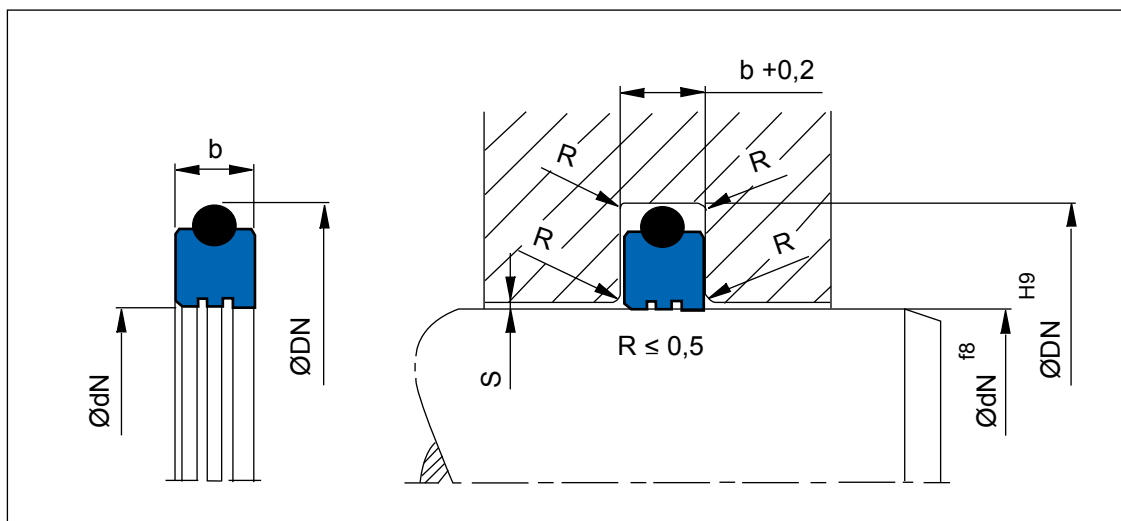
Diâmetro alojamento ØdN (mm)		Interferência (mm)
Maior que	Até	
-	25	0,50 a 1,00
25	50	1,00 a 1,50
50	100	1,50 a 2,00
100	200	2,00 a 2,50
200	500	2,50 a 3,00
500	1000	3,00 a 3,50
1000	-	3,50 a 4,00

Altura (b)		Tolerâncias (mm)
Maior que	Até	
-	5	±0,10
5	10	±0,15
10	-	±0,20

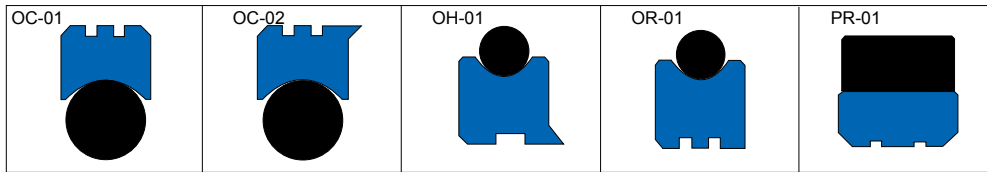
di = Diâmetro interno
De = Diâmetro externo
DN = Diâmetro da camisa
dN = Diâmetro do alojamento

ØdN	ØDN	b	Cód. CBV	Material	*Modelo	Conversão
12,00	19,00	3,20	53961	63 PGR 925	OR-01	63 PGR 925
34,40	45,70	4,20	53851	63 PGR 925	OR-01	63 PGR 925
75,00	86,00	4,20	53818	63 PGR 925	OR-01	63 PGR 925
100,00	111,00	4,20	45894	70 PBZ 905	OR-01	70 PBZ 905
110,00	99,00	4,20	50364	62 PFM 915	OC-01	62 PFM 915
110,00	121,00	4,20	46091	70 PBZ 905	OH-01	70 PBZ 905
120,00	131,00	4,20	51868	70 PBZ 905	OR-01	70 PBZ 905
180,00	191,50	4,20	50380	50 TRS 930	OH-01	50 TRS 930
225,00	245,00	8,00	46655	85 CHV 100	OR-01	85 CHV 100
234,50	253,50	7,00	46652	85 CHV 100	OR-01	85 CHV 100
260,00	271,20	4,20	50514	62 PFM 915	OH-01	62 PFM 915
280,00	269,60	4,20	50511	62 PFM 915	OC-01	62 PFM 915
310,00	320,40	4,20	50512	62 PFM 915	OH-01	62 PFM 915
380,00	391,20	4,20	50513	62 PFM 915	OH-01	62 PFM 915
460,00	483,00	8,00	46682	85 CHV 100	OR-01	85 CHV 100
480,00	503,00	8,00	46683	85 CHV 100	OR-01	85 CHV 100
481,50	503,50	10,00	46528	85 CHV 100	OR-01	85 CHV 100
559,80	591,00	10,00	46517	85 CHV 100	OR-01	85 CHV 100



Tabela de Conversão

Cód. Mercado	Cód. CBV
00002B	15261
00004B	13839
00004BR	47400
00005B	13829
00006BA	13857
00007B	15792
00008B	15185
00009BR	12224
00010GA	19791
00012BA	13182
00013B	14134
00013BRG	14140
00014BGO	14124
00015GA	19590
00015GR	47402
00016B	12673
00017B	11885
00019BR	12631
00021B	50353
00021B	48951
00025B	15423
00026GA	19271
00028B	11923
00030B	14638
00033B	12235
00033BAG	47410
00037B	13868
00042BR	16589
00043BA	15838
00044BR	14869
00045B	15703
00045B	15701
00045BAG	47424
00046BR	14947
00047B	13792
00047BAGF	12681
00048BR	13742
00049B	12619
00049BAG	12613
00051BR	14567
00051BRG	14566
00051BRP	56664
00054BR	11572
00056B	11645
00058B	14612
00058BA	14610
00063BG	13221
00063BRG	38374
00065GA	19834
00066BAG	19374
00067BRG	14139
00069B	13147
00070BA	14185
00072BA	13546
00081B	14746
00085B	15441
00087B	14879
00089B	10093
00092BGOE	13388

Cód. Mercado	Cód. CBV
00093BA	13878
00097BRE	10415
00098B	14911
00099B	16240
00100B	11009
00101B	13122
00101BAG	47447
00109B	14097
00114GR	19178
00116B	14923
00116BAG	47473
00117GR	19110
00118BA	10968
00118BAG	10965
00119GA	18804
00120BAG	14478
00121BA	11445
00122GA	19108
00123B	20219
00125B	16159
00127B	11664
00128BA	13129
00128BR	13130
00129BR	10273
00131BR	11734
00133BR	12901
00134B	15269
00136BA	12368
00141BA	11333
00141BAG	47477
00145B	11368
00146B	14094
00150BA	11016
00155B	13415
00156B	49253
00156BR	10466
00156BRO	10493
00157BA	13530
00158B	10706
00159BR	10702
00160BR	16963
00160BRG	47249
00161BRG	13485
00162BR	13644
00164BAG	14574
00164BAG	14568
00164BR	14573
00166BR	12803
00170BA	50355
00170BRG	20235
00188BA	14136
00191BR	11219
00198BA	10053
00203BR	12597
00211BGO	16794
00214BR	12313
00218B	12461
00219BR	13077
00220BAE	13440

Cód. Mercado	Cód. CBV
00221B	15153
00222BAG	13178
00223BR	14246
00223BRG	14241
00228BAG	14645
00229B	13567
00231BRG	19705
00248BR	16702
00250BR	16296
00250BRP	13101
00254BAO	12486
00258GA	19266
00262B	11533
00262BA	11531
00262BA	11534
00264BR	13439
00265BR	12761
00266BR	11267
00268BR	17186
00268BRG	17183
00268BRP	10453
00269BAGS	38605
00269BR	15008
00272BRG	13200
00273B	14066
00273B	14066
00274BGO	13754
00276B	13158
00283BR	11173
00284BR	12201
00285BA	11437
00286BR	10488
00288BR	12934
00289BA	10209
00289BR	10211
00291B	13559
00291BR	13560
00293BR	10356
00294BR	10959
00300B	15532
00302B	13314
00309B	16412
00310B	16423
00310BG	16424
00311B	10279
00321BA	14071
00322BA	50359
00322BR	12073
00323BGO	14968
00334BAG	14302
00338BGO	10733
00343BR	11898
00357B	15074
00357BA	15073
00357BAG	47740
00358BR	11750
00359BR	13241
00359BRG	13240
00360BA	10853

Cód. Mercado	Cód. CBV
00360BR	54518
00361BA	12972
00361BR	12970
00366B	15624
00368BAG	13392
00369BR	14634
00371B	14328
00373GA	19372
00375BA	10534
00376B	14739
00378B	14491
00379BR	14643
00405B	13404
00420BR	16365
00421BAGG	14924
00423BR	14809
00423BRG	14810
00434B	14654
00436B	13920
00436BAG	13887
00439BR	15855
00442BR	15645
00448BA	11311
00455BA	11833
00455BAG	47697
00455BRG	53678
00456BA	14072
00459BR	13997
00460BR	14414
00460BRG	47232
00460BRGF	54284
00463BR	11288
00463BRG	11289
00466B	15165
00468B	13722
00469B	11212
00470BA	12582
00470GA	19336
00477BA	12026
00479BR	12520
00479BRG	12517
00479BRG	12521
00480BA	15273
00482GAF	39142
00484BA	11755
00485BA	12266
00485BAG	54627
00486BA	12510
00490BR	14787
00491B	15976
00492BA	12336
00495BA	11978
00496BRG	10647
00497BRG	15578
00498BR	13995
00498BR	13995
00498BRG	55197
00499BR	11272
00500BAG	14679



Tabela de Conversão

Cód. Mercado	Cód. CBV
00500BAGF	39051
00500BAGP	14228
00501BR	14220
00502BR	16665
00503BR	11550
00504BGO	15202
00505BR	10791
00506BR	11241
00508BA	10567
00508BAG	10565
00509BR	13280
00514BR	16185
00514BRS	51128
00515GA	18794
00516BG	16091
00517BR	14283
00519BA	11873
00520BR	12274
00521BR	12963
00522BRG	13479
00527B	13457
00533BA	47664
00536B	16019
00541B	10363
00546BR	16286
00547B	14203
00554BA	13169
00561BAG	12979
00563BR	51037
00564BR	13013
00566BA	13447
00567BR	13402
00569B	10722
00569BR	10724
00572BR	11020
00573B	14955
00577BGOP	40324
00581BR	11569
00586BR	13721
00586BRG	13720
00588B	13134
00593B	15283
00604BR	13044
00607B	11518
00608B	20226
00609BR	15003
00610BR	15197
00612BR	15329
00615BR	12428
00616BR	15922
00618BAG	15378
00620B	13974
00626BGO	12893
00630B	47577
00630BG	13731
00630BR	54355
00631B	15899
00634B	11595
00634BAG	47581

Cód. Mercado	Cód. CBV
00642B	47582
00642BRG	15519
00644B	15290
00644BG	15289
00649B	16605
00649BGO	16604
00650B	15997
00651B	14614
00652BG	14487
00653B	13693
00660B	13753
00674B	13423
00688BAP	40331
00692B	12907
00694B	12196
00701B	50373
00708BR	13514
00708BRG	13534
00709BR	11244
00712BR	10798
00713GA	19083
00714BA	10757
00715BA	10811
00716B	10354
00726BR	10541
00734BR	13088
00735B	14064
00737BA	15464
00745BGO	10683
00749BA	13081
00752BA	13751
00758BR	12314
00760BR	10823
00760BRF	54525
00761BR	10978
00762BR	11876
00763BR	11136
00764BA	10139
00766BA	10413
00767BA	10794
00768B	46952
00769BA	18941
00770B	11301
00771BA	11620
00772BA	11791
00774B	11920
00775BA	13079
00776BA	14013
00780BR	16379
00784BR	10699
00784BRG	47248
00785BA	11421
00788BAG	11170
00789B	12288
00789BA	12287
00789BR	12289
00790BR	10382
00793BA	14006
00795BR	10520

Cód. Mercado	Cód. CBV
00796BR	10525
00797BR	12424
00798BA	10696
00800BA	12361
00801BR	56622
00801BR	12010
00803B	16081
00803BA	16079
00803BAG	16077
00803BAS	38623
00803BRG	16078
00803BRGF	50827
00803BRGS	38622
00804BR	13971
00805BGO	14418
00807BA	10021
00810BA	11687
00813BA	20232
00813BAG	20233
00815BR	47430
00816BAG	12087
00817BR	11798
00818BR	14257
00819BR	15134
00821BR	10695
00822BA	12257
00824B	11757
00828BR	10600
00829BR	11124
00832BR	11715
00834BR	13640
00837B	12826
00838B	13852
00839BR	11998
00843B	13811
00844B	11357
00847BAG	11697
00847BR	11700
00847BRF	38919
00848GA	19592
00849BA	13364
00853BR	10592
00866BR	14806
00867BR	13802
00871BGO	12694
00877BR	13098
00879BR	12188
00879BRG	52118
00880BR	12751
00888GA	10685
00891BRG	14738
00893BA	14981
00897BR	12788
00900BR	15226
00903BA	14560
00906BR	14766
00907BR	19840
00909BR	10873
00911BRG	11752

Cód. Mercado	Cód. CBV
00912BRG	12309
00913BR	12843
00916BA	10399
00918BR	10827
00919BR	14055
00920BR	12490
00922BR	10852
00924BR	12765
00925BA	11227
00926BR	14547
00932BR	11570
00934B	11338
00937B	11025
00937BAG	11021
00937BGO	11022
00946BR	13625
00947BR	11535
00949BR	11775
00950B	13889
00951GA	19446
00952BR	11769
00953BR	10801
00955BAG	10963
00959B	10701
00961B	11627
00962BR	12282
00962BRG	47481
00963BAG	10908
00964B	14010
00969BR	12270
00974BA	13820
00977BR	14260
00980BA	10504
00981GA	18755
00989BA	10698
00989BAG	10727
00992BRG	10980
00994BA	10845
00994BRG	10842
00995BA	12628
00998BR	10069
01009BR	11354
01012BGO	13886
01017BR	13522
01019BR	11190
01020B	11543
01022BR	11497
01035GR	19732
01038B	13302
01038B	13305
01040BA	12107
01041B	12159
01043B	15705
01044BAG	14940
01045BRG	11407
01046BAG	12755
01048BR	12119
01048BR	12119
01050BR	14312



Tabela de Conversão

Cód. Mercado	Cód. CBV
01050BRGS	38584
01051BR	10433
01051BRG	10432
01058BR	10425
01063BA	11814
01067BR	10148
01072BA	10561
01072BR	10563
01074BRG	10309
01076B	10414
01081BR	12992
01093BR	10085
01095BRG	13113
01097BR	10276
01097BR	10313
01100BAG	12862
01103B	16049
01107BR	10673
01107BRF	54281
01109BR	12801
01109BRG	12800
01109BRGF	38979
01110BR	10713
01112BR	11032
01113BRG	10593
01116BR	12784
01118B	11193
01119BAG	13154
01121GR	19138
01135B	14777
01135BA	14776
01135BR	14778
01135BRF	39059
01135BRG	14775
01135BRGF	39060
01135BRGS	38600
01135BRP	38599
01135GR	19909
01138BR	19335
01140BR	13375
01141BR	13248
01147BRG	13453
01148BR	15172
01149BA	11892
01149BR	11893
01151BRG	11417
01152GR	19288
01154B	11901
01155B	12738
01156GR	19044
01157BR	12133
01160BR	14542
01175BA	10455
01180BR	14003
01181BR	13941
01182BR	11822
01183BR	15021
01187BR	13841
01188BR	11563

Cód. Mercado	Cód. CBV
01189BR	10839
01193BR	16462
01194BR	14270
01195B	15297
01207BAG	13253
01214BR	11122
01235BR	10711
01241BAG	13513
01245BR	20230
01247BA	13978
01251BGO	15647
01252BGO	15909
01253B	15531
01254BAG	10904
01257B	15680
01262BAG	13516
01265BAG	12752
01266BAG	12811
01268BA	15953
01273BA	11811
01278BA	13912
01284B	12588
01295GR	18627
01299BR	11565
01301BA	15168
01302B	11376
01306GR	19495
01310BAG	11968
01318B	12643
01322BR	12797
01327BAG	11331
01328BA	10795
01340BR	13613
01341BR	11129
01343BAG	12371
01344BR	13245
01345BA	19810
01348BR	10419
01353BRG	12014
01355BR	12511
01356BAG	11323
01362B	16530
01366B	12387
01369BA	13419
01370BA	11975
01371BAG	12322
01375BR	15806
01377B	11935
01378B	12892
01386BR	10819
01386BRG	10820
01389BAG	10329
01392BAG	14249
01393BA	11385
01395B	12187
01396BA	12526
01397BA	11245
01400BR	10677
01404BR	10810

Cód. Mercado	Cód. CBV
01405GA	19030
01407BR	10705
01408BA	14459
01412B	16166
01415BRG	10597
01416BAG	15529
01419GA	19404
01420BR	10228
01420BRG	55700
01421BR	12426
01422BR	13598
01422BRF	39006
01422BRG	13599
01422BRGF	13690
01422BRS	38572
01423BR	10055
01424BR	16821
01425BA	14431
01427BR	16108
01432GA	19343
01445BA	18729
01454BGO	14597
01455BA	10716
01460B	19599
01462B	14591
01464BA	10576
01465BA	10759
01468B	16047
01479BR	10161
01481BA	11044
01489BGO	14605
01491BA	12719
01492BR	10607
01492BRF	54419
01493BR	10492
01495BR	11501
01495BRF	38913
01495BRS	38541
01496BR	10629
01502BA	12148
01505BR	12977
01506BF	38985
01507BR	11132
01508B	10272
01509BR	12125
01509BR	12125
01511BR	10596
01515BR	11178
01519BR	13432
01524BR	15484
01526BRG	12150
01527BA	10691
01532BR	13124
01535BR	11685
01536BA	12575
01539GA	19104
01541BAG	14465
01543BA	11167
01543BR	11168

Cód. Mercado	Cód. CBV
01547BGO	11389
01549BR	15819
01550BR	13951
01550BRP	40308
01551BR	12342
01552BR	13063
01553BR	19540
01553BR	13267
01554BRG	10947
01556BR	11207
01557BR	13949
01559BR	10257
01563BA	11986
01566BAO	11584
01576BAG	10451
01577BR	11184
01577BRF	38901
01577BRG	11186
01580B	11509
01581BGO	11819
01587BR	10065
01589BR	12056
01602BAG	12837
01603BRG	12044
01604BR	11223
01604BRG	11224
01604BRGF	38903
01608BR	12480
01613GA	18975
01625BRG	11477
01630BAG	11883
01635BR	11634
01637GA	19736
01656BR	13143
01657BA	50524
01657BAG	12540
01659BA	12587
01660BAGE	19376
01661BAG	47583
01666BR	11116
01667BR	11703
01669BR	14014
01669BRG	14011
01671GA	13706
01672 BRG	10122
01672 BRG	38869
01672BR	10120
01673BA	14987
01676BR	17152
01677BR	10410
01679BRG	13137
01683GA	19066
01685BR	10002
01687BA	15013
01694BA	10841
01694BAP	40263
01695BR	11718
01698B	11915
01699BR	13474



Tabela de Conversão

Cód. Mercado	Cód. CBV
01700GR	18814
01703GR	19193
01707BRG0	12733
01710BAG	12569
01711BRG	13232
01712BAG	11146
01715BR	11973
01716BR	10960
01717GA	18768
01718BR	10808
01718BRG	52117
01719BR	15471
01721BR	15833
01721BRGP	40329
01723BAE	10865
01725BR	50527
01725BRG	10581
01726BR	11976
01727BR	10945
01735BG	16368
01737BR	10151
01738B	13205
01739B	16080
01740B	13602
01742BR	12308
01742BRG	12305
01743BS	38547
01744B	12007
01745BRG	12743
01746B	10862
01751BRG	11475
01755BA	14300
01759GR	19409
01760GR	19532
01764BRG	13319
01767BR	15370
01769BR	10665
01769BRG	10668
01770B	16231
01774BRG	15981
01777GA	18911
01778GR	19064
01779B	10874
01783BRG	13600
01784BRO	18842
01785GA	19070
01786BRG	12523
01790B	14460
01793BR	13471
01798BAG	14170
01801B	15818
01802BR	12954
01803BAG	12579
01807BAG	13627
01809BS	38562
01810BAGS	38595
01811B	12704
01814BRG	12433
01816BA	10381

Cód. Mercado	Cód. CBV
01817BA	10512
01819BA	10962
01822BAP	40333
01825BRG	13872
01828B	14404
01829B	15558
01830GA	19063
01831BA	11732
01832BR	12547
01833BA	11710
01835BA	10334
01835BR	14993
01836B	11093
01839BA	12047
01839BR	12049
01840BGO	13460
01841BRG	14259
01843BA	11894
01844BAG	12210
01845BRP	40297
01846BAG	10408
01847GR	19630
01849BAG	12054
01851BRG	13204
01852BRS	38606
01854BRG	12614
01855BAG	13678
01856BRGP	40321
01857B	15059
01858BAG	13083
01859BAG	13105
01860BA	11423
01861BRG	13643
01862BRAG	14076
01863BA	14480
01864BAG	13876
01865BGO	14741
01866GR	18910
01867GR	18981
01868GA	20228
01869GA	19381
01870GA	19841
01871GR	18853
01875BR	10349
01878B	13729
01879BRG	14797
01880BAG	14744
01882GA	12476
01883BAG	10924
01884B	16255
01884BG	16256
01885BAG	47609
01885BAGF	46881
01885BAGP	47459
01885BAGS	38626
01886GR	19090
01892BRG	11189
01894BRG	10814
01901BGO	15890

Cód. Mercado	Cód. CBV
01902BR	13486
01903BRP	40279
01904BRP	40252
01906BA	13274
01907BR	10422
01909BR	10689
01910BRP	40334
01910BRS	38636
01911BRG	11378
01911BRGF	38910
01912BRG	15416
01914BRP	40271
01915BAGP	40256
01916BAGP	40257
01917BRGS	38607
01923BG	15304
01927BRP	40319
01928B	16755
01929BA	10379
01929BAG	10378
01929BRG	10380
01929BRGF	54629
01930BAG	20237
01931BAG	12923
01934BAG	20225
01935BAG	10787
01942BRGP	40283
01945BRGS	38610
01949BR	12363
01950BAG	13791
01951BR	16936
01952BA	11781
01953BRG	16521
01954BR	12401
01955BAGS	38566
01957BA	10275
01958BAGS	38560
01959BAG	10427
01962BA	11580
01962BAG	47486
01963BAG	12861
01964BA	11566
01965BAP	40260
01966BA	10265
01967BAS	38537
01968BRS	38619
01969BRGS	38577
01972BRGS	38632
01973GA	19624
01974BRG	15835
01976B	16982
01977GR	18781
01980BR	12316
01981BRGS	38611
01984GA	49249
01985BR	10926
01986BR	17245
01988BRG	12721
01989BAG	12871

Cód. Mercado	Cód. CBV
01992BR	11866
01993BR	11438
01994BR	13564
01995BR	14177
01996BRO	19466
01997BRO	19373
02001GA	18717
02004BAGP	40315
02005BAGP	12750
02006BAG	11763
02007BAGP	40273
02009BP	40270
02010BA	11258
02010BAG	11261
02010BR	11260
02010BRG	11259
02010BRO	19023
02012BR	54800
02012BRF	38940
02013BAP	40251
02014BAGP	40296
02021B	16036
02024BRG	13370
02025BA	10322
02029BR	11088
02031BR	12748
02034BRG	12629
02038BRG	12684
02039BR	50532
02046BRG	11264
02049B	15810
02049BG	15811
02051BR	12525
02052BAGP	40282
02053BAGP	40290
02054BR	16942
02055BR	13398
02055BRF	51379
02056BR	16961
02058BAGF	38983
02059BA	12943
02061BRGF	39063
02062BA	11203
02063BAG	11922
02064BAG	11062
02066BAG	14074
02067BAG	14081
02068BRG	40287
02069BRGS	38630
02072BAP	40261
02073GA	18936
02077BAG	14311
02084BAGP	40292
02084BAP	40291
02085BA	14721
02087BAG	12335
02088BGO	12813
02091BAG	12357
02091BAG	12364



Tabela de Conversão

Cód. Mercado	Cód. CBV
02092BGO	16223
02093BRG	16830
02095GA	19284
02096BA	11677
02099BA	12423
02100BAG	14147
02102BA	12175
02103BAG	14100
02104BA	13116
02106GA	19095
02107GA	19007
02108BRG	13611
02110BRG	13215
02110BRG	13218
02111BRG	13953
02112BRG	14145
02113BR	14589
02115BRG	38627
02116BAP	40312
02117BAS	38620
02125BGP	40328
02126GA	18948
02126GA	40341
02127BGP	40322
02128BA	12554
02130BAG	10373
02131BAG	10718
02135GA	18708
02138B	17065
02140BAP	40278
02142BRGF	38937
02144GR	19219
02145BRG	11508
02148BRG	11210
02151BA	12397
02153BR	38916
02153BRG	50547
02156BAGF	39119
02157BRO	19094
02161BR	10553
02162BRG	10327
02163BRG	10054
02164BRG	10671
02166BRG	10026
02169BA	13214
02171BR	10111
02172BG	11329
02175BA	13201
02175BRG	40298
02176BRG	10496
02177BRG	38539
02178BAGS	47571
02178BRGS	38552
02180BG	16170
02181BAG	14028
02184BAGP	50573
02185BAG	16662
02185BAGF	50574
02191 BR	14996

Cód. Mercado	Cód. CBV
02191 BRF	39069
02192BRGP	40318
02193BRG	14083
02195BR	15983
02196BR	13170
02197BRG	13862
02198GR	18681
02199BAGF	50828
02203BAG	10684
02204BAGP	40313
02205BAGP	40307
02206BAGP	40311
02207BAGP	40306
02208BGP	40325
02210BRG	11115
02213B	15779
02214B	16157
02215BG	11896
02223B	16681
02224BR	12332
02225BR	12823
02226BG	15012
02230B	11326
02233BRG	11208
02234BRG	11705
02235BAG	38609
02236BAP	40309
02240BA	11031
02242BG	12095
02244B	11655
02245BAG	16524
02246BAG	20173
02248GA	18704
02249GA	18749
02255GA	40340
02256BAG	14522
02262BAG	13711
02263BR	10694
02264BRGF	39082
02265GA	19000
02270B	12035
02271BGP	40338
02272BGP	40337
02279BAG	10394
02283BRGF	39080
02285BA	10793
02287BGP	40336
02289BAG	12568
02291BAF	39076
02292BAF	39055
02293BF	39126
02295BA	13059
02296BRG	12947
02297BAGF	39058
02302BAGF	38975
02303BRG	12372
02304BAG	47731
02304BRG	12221
02306BRG	10025

Cód. Mercado	Cód. CBV
02308BRG	10339
02309BR	10389
02309BRP	40255
02310BRG	10503
02315GA	19258
02316GA	19764
02317BRAGF	38932
02321BAG	12935
02322GA	19417
02324BRG	13235
02324BRG	54003
02325BRG	15564
02325BRGF	39092
02325BRGP	47733
02326BRG	14160
02326BRGP	47721
02334BAG	10370
02335BAG	10450
02337GA	19114
02342GA	12396
02343BAP	40253
02349BAG	13377
02352B	15406
02353BRGE	12278
02355BA	11575
02356BA	12864
02357BA	11012
02358BA	10027
02360BRF	38876
02361GA	19103
02371BAG	10927
02372BAG	11071
02373BRG	10306
02375BR	10562
02376BRG	11721
02377BG	12676
02378BR	14548
02381BA	14101
02385BA	12576
02386BG	16024
02395BAGG	13282
02397BRG	11980
02398BAGS	38598
02399BRGS	38592
02401B	11770
02407BA	11800
02412BRG	11412
02413BA	11489
02413BRG	47706
02414BRG	20231
02415BAG	14019
02416BAG	15313
02418BRP	10940
02419BAG	12740
02422BRP	40316
02423BAG	14724
02424BG	15494
02430BRGF	38969
02433BRG	10844

Cód. Mercado	Cód. CBV
02441GRG	18785
02444GA	12505
02445BR	14676
02445BRG	14673
02449BRGF	39115
02450BRS	38615
02451BRG	14982
02454BRG	10390
02456BRGS	38553
02465BAG	11091
02468BRG	10847
02474BRG	10168
02478BAGF	39046
02480BAGP	40266
02486BR	10816
02486BRG	47722
02491GR	38389
02492GA	46909
02492GR	38390
02492GR	18826
02495BRF	39143
02498BRGF	39047
02499BRGF	39056
02504BAGP	40314
02506BR	12516
02510GA	18861
02515GR	38388
02519BRG	11499
02522GA	19544
02523BRF	38870
02527BAGP	40276
02529BRG	13987
02530BRG	50379
02531BR	14992
02531BRG	14991
02533BRGP	40268
02535BRG	18737
02536BR	49250
02536BRG	10049
02541BRGP	40288
02549BRP	40277
02556BAF	39053
02557BRG	14695
02558BAF	39002
02559BAF	38966
02560BGF	39064
02560BR	54556
02566BRGF	39157
02567GR	10635
02568BRG	11401
02569BRGP	40254
02570BRG	11201
02570BRGF	38902
02571BRG	10552
02572BRG	10958
02573GA	18900
02573GR	18901
02574BR	15545
02574BRG	15548



Tabela de Conversão

Cód. Mercado	Cód. CBV
02574BRG	52212
02578BRGF	39043
02579BRG	10955
02580BAG	13119
02583BRGF	39152
02588GR	19001
02589GR	18784
02591BRG	13310
02594BRF	47586
02604BRGF	39094
02606BAF	39077
02607BRG	39079
02627GR	20227
02632GR	19286
02633GR	19403
02634GR	19529
02635GR	13932
02636GR	19798
02637GR	14765
02638GR	10192
02639GR	10376
02640GR	10554
02641GR	18904
02641GRF	47480
02643GA	19141
02643GR	14392
02658BRG	38987
02660BRGF	39021
02661BRG	15193
02661BRG	52169
02662BRG	15198
02664BAGP	40323
02664BRF	39075
02664BRGS	38642
02667BRGP	40310
02669GA	18838
02671BRG	12990
02671BRGF	39071
02675BRG	12849
02677BRG	14767
02678BRGS	38543
02679BRG	16752
02685BR	14279
02689BAG	10196
02690BRG	15678
02691GA	20250
02699BRG	12006
02701BRG	10558
02712BRGP	40274
02715GA	10941
02720BRGP	40299
02721BRGP	40302
02723BAF	39003
02727BRG	11283
02729BA	10944
02730BRG	10572
02731BAGF	38915
02732BRG	12402
02736GA	19527

Cód. Mercado	Cód. CBV
02739BRG	12742
02739BRGF	38974
02740BRGP	40269
02751BRG	15577
02753BRG	14995
02759BAG	14892
02762BR	10051
02778B	16738
02778BAG	47588
02780BRF	39072
02784BAGF	38990
02787BAGF	38871
02788GA	11676
02792BAG	10001
02802BRG	47674
02802BRGF	38899
02813BRG	20234
02821BRG	10812
02822BRG	12717
02832BRG	16087
02837BAG	38896
02847GA	13930
02868BRG	16361
02873BRG	10012
02877BAG	19101
02878BAG	47590
02879BAG	19421
02880BG	13161
02930BRGP	40281
02932BAGF	39128
02933BRG	16817
02942BAG	10296
02943BAG	10318
02944BAG	10585
02955BRF	39037
02962BRGF	38946
02963BROF	48635
02972BAG	48809
02977BRS	38544
02981GA	19470
02985BRF	39106
02987GR	11977
02990BAG	47445
02999BRG	14885
03004BRG	10834
03005BR	10117
03017BAGF	15192
03250BRG	49252
03251BRG	12134
03252BR	20247
03254BR	49248
03255BR	10202
05040BAG	40265
05041BAG	40272
05043BAG	40284
05126BRF	48784
05148BR	18735
05250BRGF	38558
05253BRGF	45722

Cód. Mercado	Cód. CBV
05254BRGF	39087
05305BRGF	39034
05308BRGP	13724
05352BRGF	14043
05353BRGF	19571
05363BRGF	12155
05420BRGF	49036
05421BRGF	19982
05529BRGP	12265
05530BRGP	47438
07023GA	48901
07299BA	19140
07408BRGP	10225
07461BRF	20110
07485BAF	13542
07599BAP	39000

Cód. Mercado	Cód. CBV
--------------	----------